

HZL-60 Series

INSTRUCTION MANUAL

**Attention**

Please read this instruction manual before using the machine as it contains important operational and safety information.
Keep this manual accessible so that you may refer to it at anytime while operating the machine.

“IMPORTANT SAFETY INSTRUCTIONS”

When using an electrical appliance, basic safety precautions should always be followed, including the following: Read all instructions before using this sewing machine.

“**DANGER** ____ To reduce the risk of electric shock:”

1. The appliance should never be left unattended when plugged in.
2. Always unplug this appliance from the electric outlet immediately after using and before cleaning.

“**WARNING** ____ To reduce the risk of burns, fire, electric shock, or injury to persons:”

1. Do not use the appliance as a toy. Caution is advised when the appliance is used by children, or near children. This sewing machine can be used by children aged from 8 years and above and persons with reduced physical, sensory or mental capabilities or lack of experience and knowledge if they have been given supervision or instruction concerning use of the sewing machine in a safe way and understand the hazards involved. Children shall not play with the sewing machine. Cleaning and user maintenance shall not be made by children without supervision.
2. Use this appliance only for its intended use as described in this manual. Use only attachments recommended by the manufacturer as contained in this manual.
3. Never operate this appliance if it has a damaged cord or plug, if it is not working properly, if it has been dropped or damaged, or dropped into water. Return the appliance to the nearest authorized dealer or service center for examination, repair, electrical or mechanical adjustment.
4. Never operate the appliance with any air openings blocked. Keep ventilation openings of the sewing machine and foot control free from the accumulation of lint, dust, and loose cloth.
5. Keep fingers away from all moving parts. Special care is required around the sewing machine needle.
6. Always use the proper stitch plate. The wrong plate can cause the needle to break.
7. Do not use bent needles.
8. Do not pull or push fabric while stitching. It may deflect the needle causing it to break.
9. Switch the sewing machine off ("O") when making any adjustments in the needle area, such as threading needle, changing needle, threading bobbin, or changing presser foot.

10. Always unplug the machine from the electrical outlet when removing covers, when lubricating or when making any other user servicing adjustments mentioned in the instruction manual.
11. Never drop or insert any object into any opening.
12. Do not use outdoors.
13. Do not operate where aerosol (spray) products are being used or where oxygen is being administered.
14. To disconnect, turn all controls to the off ("O") position, then remove plug from outlet.
15. Do not unplug by pulling on cord. To unplug, grasp the plug, not the cord.
16. Basically, the machine should be disconnected from the electricity supply when not in use.
17. If the power cord of this appliance is damaged, it must be replaced with a special cord by your nearest authorized dealer or service center.
18. (Except USA/Canada) This machine is provided with double insulation. Use only identical replacement parts. See instructions for servicing Double-Insulated machine.
19. When you sew slowly for long time, machine will have heat or unusual smell occurs. In this case, disconnect the plug from the wall outlet and use it after a while. Contact your nearest dealer if it still occurs.
20. Don't use the machine if it's wet or in humid environment.
21. The sewing machine is equipped with a LED lamp. If the LED lamp is broken, it must be replaced by the manufacturer or its service agent in order to avoid a hazard.
22. Never place anything on the foot control.
23. The machine must only be used with foot controller type C-8001 manufactured by CHIEN HUNG TAIWAN., LTD..
24. The sound pressure level under normal operating conditions is 75dB(A).
25. Keep the instruction at a suitable place that close to the machine, and hand it over if you give the machine to a third party.

“SERVICING DOUBLE-INSULATED PRODUCTS (Except USA / Canada)”

In a double-insulated product, two systems of insulation are provided instead of grounding. No grounding means is provided on a double-insulated product nor should a means for grounding be added to the product. Servicing a double-insulated product requires extreme care and knowledge of the system and should only be done by qualified service personnel. Replacement parts for a double-insulated product must be identical to those parts in the product. A double-insulated product is marked with the words DOUBLE INSULATION or DOUBLE INSULATED.

The symbol  may also be marked on the product.

⚠ WARNING

For the combination of the material and the thread and needle, in particular, refer to the explanation table in "Replacement of the needle".

If the needle or thread does not match the material used such as in the case that an extra heavyweight material (e.g., denim) is sewn with a thin needle (#11 or higher), the needle can break resulting in an unexpected personal injury.

Other precautions

- Do not put the sewing machine under the direct sunlight or in a humid place.

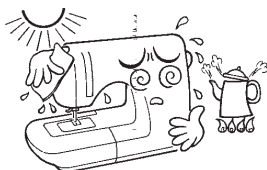

- Do not wipe the sewing machine with solvent such as thinner.

When the sewing machine is soiled, put a small quantity of neutral detergent on a piece of soft cloth and carefully wipe off the sewing machine with it.

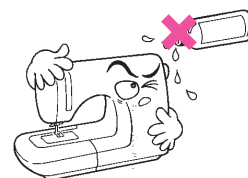

Be aware that the following state can take place since the sewing machine incorporates semi-conductor electronic parts and precise electronic circuits.

- Be sure to use the sewing machine in the temperature range from 5°C to 40°C. If the temperature is excessively low, the machine can fail to operate normally.

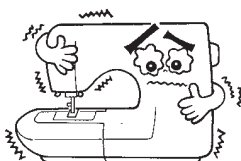

* The operating temperature of the sewing machine is between 5°C and 40°C. Do not use the sewing machine under the direct sunlight, near the burning things such as a stove and candle, or in a humid place. By so doing, the temperature in the interior portion of the sewing machine can rise or the coating of the power cord can melt, causing fire or electrical shock.



Do not dispose of electrical appliances as unsorted municipal waste, use separate collection facilities.

Contact your local government for information regarding the collection systems available.

If electrical appliances are disposed of in landfills or dumps, hazardous substances can leak into the groundwater and get into the food chain, damaging your health and well-being.

When replacing old appliances with new ones, the retailer is legally obligated to take back your old appliance for disposal at least for free of charge.

"SAVE THESE INSTRUCTIONS"

"This sewing machine is intended for household use only."

Congratulations on your purchase of a JUKI sewing machine.



Please be sure to read safety precautions in "To use the sewing machine safely" in the Instruction Manual before use to fully understand the functions and operating procedures of the sewing machine so as to use the sewing machine for a long time.

After you have read the Instruction Manual, please be sure to keep it together with the warranty so that you can read it whenever necessary.











To use the sewing machine safely

Marks and pictographs included in the Instruction Manual and shown on the sewing machine are used so as to ensure safe operation of the sewing machine and to prevent possible risk of injury to the user and other people.

Warning marks are used for different purposes as described below.

 WARNING	Indicates that there is a possible risk of death or serious injury if this mark is ignored and the sewing machine is used in a wrong manner.
 CAUTION	Indicates the operation, etc. which can cause a possible risk of personal injury and/or physical damage if this mark is ignored and the sewing machine is used in a wrong manner.

Pictographs mean the following:

	Danger warning which is not specified		There is a risk of electrical shock		There is a risk of fire		There is a risk of injury to hands, etc.
	Prohibited matter which is not specified		Disassembly/alteration is prohibited		Do not place fingers under the needle		Do not pour oil, etc.
	Generally required behavior		Disconnect the power plug				

CONTENTS

GETTING READY TO SEW

Principal parts of the machine	10
Sewing table	11
Accessories	11
Type of presser foot chart	12
Connecting the machine	13
Winding the bobbin	14
Inserting the bobbin.	15
Threading the upper thread.	16
Using the needle threader.	17
Raising up the lower thread	18
Adjusting presser foot pressure	19
Replacing the needle	20
Changing the presser foot.	21
Two-step presser foot lifter	22
To raise or drop the feed dogs	22
Matching needle/ fabric/ thread.	23
Buttons of the machine	24-27
Start/stop button (1)	24
Reverse button (2)	25
Auto-Lock/Stop button (3)	25
Needle up/ down position button (4)	25
Speed limiting adjustment lever (5)	25
Stitch width adjustment lever (6)	26
Stitch length adjustment lever (7)	27
Pattern selection buttons (8)	27

SEWING BASICS

Pattern chart	28
Thread tension	29
USEFUL SKILLS	30-31
Sewing corners	30
Reverse.	30
Free arm	30
Sewing on the heavy fabric.	31
Cutting the thread	31
Straight stitches and needle position	32
Zigzag stitches	32
Stretch stitch	33

ORDINARY SEWING

Overcasting stitches	34
using the overcasting foot	34
using the standard presser foot	34
Blind hem/ lingerie stitch	35
Button sewing	36
Buttonhole stitching	37-40
Making a buttonhole on stretch fabrics	40
Darning stitch	41-42
Zipper insertion	43-44
inserting a centered zipper	43
inserting a side zipper	44
Narrow hemming	45
Cording	46
single cording	46
triple cording	46
Satin stitch sewing	47
Quilting	47
Scalloping	48
Scallop hem	48
Scallop stitch	48
Gathering	49
Smocking	50
Free motion darning, embroidery and monogramming	51-52
Darning	51
Embroidery	52
Monogramming	52
Fagoting	53
Patchworkstich	53
Twin needle	54
Walking foot	55

APPENDIX

Warning functions	56
Warning beeping sound	56
Return bobbin winder spindle to left	56
Maintenance	57-58
Cleaning the sewing machine surface	57
Cleaning the hook	58
Trouble shooting guide.	59-60

Principal parts of the machine

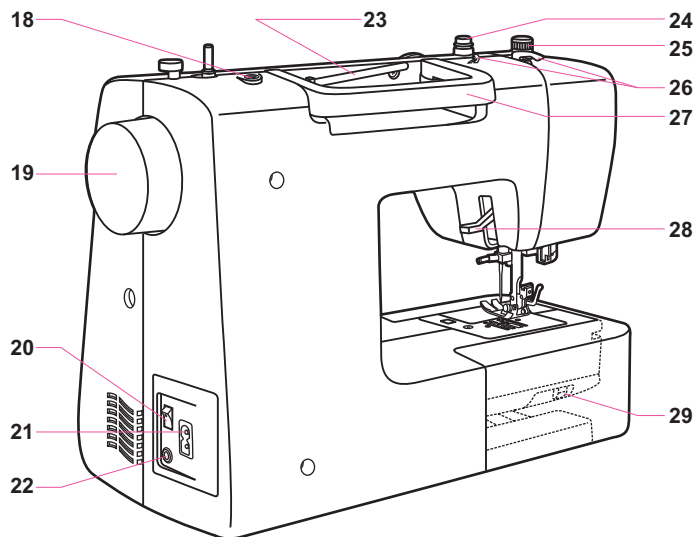
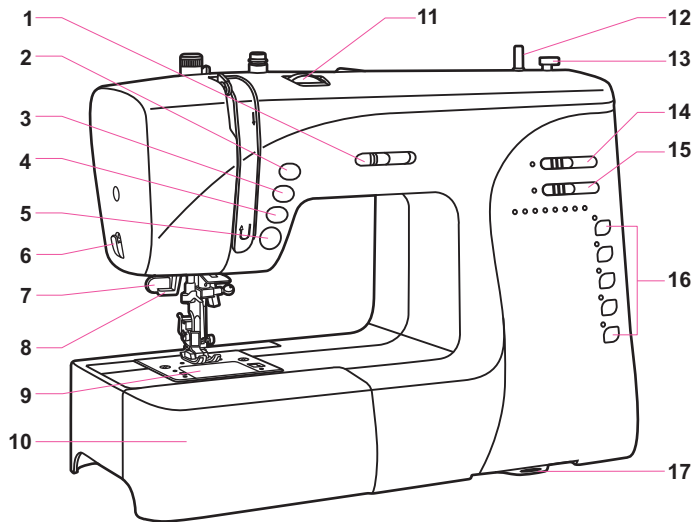

1. Speed limiting adjustment lever
2. Needle up/down position button
3. Auto-lock button
4. Reverse button
5. Start/stop button
6. Thread cutter
7. Buttonhole lever
8. Auto needle threader
9. Bobbin cover plate
10. Sewing table and accessory box
11. Tension dial
12. Bobbin winder spindle
13. Bobbin winder stopper
14. Stitch width adjustment buttons
15. Stitch length adjustment buttons
16. Pattern selection buttons
17. Stitch pattern plate
18. Hole for auxiliary spool pin
19. Handwheel
20. Main power switch
21. Main plug socket
22. Foot controller connector
23. Horizontal spool pin
24. Bobbin thread guide
25. Presser foot pressure
26. Upper thread guide
27. Handle
28. Presser foot lifter
29. Drop feed lever

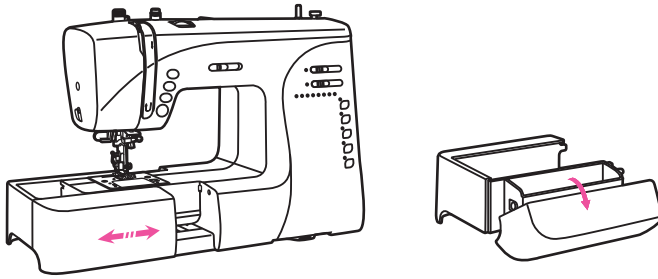

Sewing table

Keep the snap-in sewing table horizontal, and pull it in the direction of the arrow.

The inside of the snap-in sewing table is used as an accessory box.

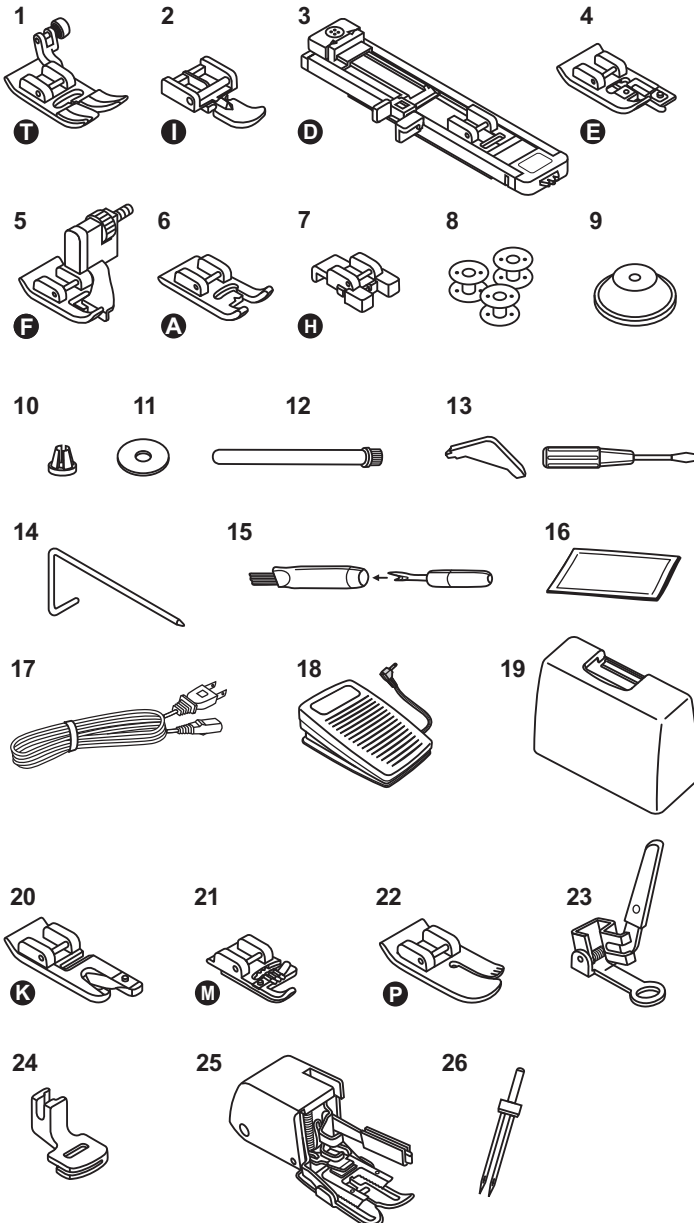

Accessories

Standard

1. Standard presser foot (T)
2. Zipper foot (I)
3. Buttonhole foot (D)
4. Overcasting foot (E)
5. Blind stitch foot (F)
6. Decorate stitch foot (A)
7. Button sewing foot (H)
8. Bobbin (3x)
9. Spool cap (Large)
10. Spool cap (Small)
11. Spool pin felt
12. Auxiliary spool pin
13. Screwdriver (L-shape & S)
14. Quilt guide
15. Seam ripper/ brush
16. Pack of needles(3x)
17. Power cord
18. Foot controller
19. Hard case





















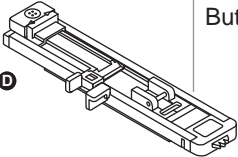













Optional

20. Rolled hemming foot (K)
21. Cording foot (M)
22. Straight stitch foot (P)
23. Quilt foot
24. Gathering foot
25. Walking foot
26. Twin needle

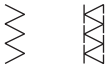
Note:

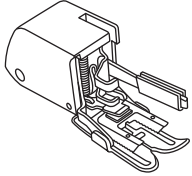
- Accessories are stored inside the accessory box.
- Optional accessories are not supplied with this machine; they are however available as special accessories from your local dealer.
- The styrofoam inside the hard case is only for transportation protection and is disposable.

Type of presser foot chart

PRESSER FOOT	APPLICATION	NEEDLE	PRESSER FOOT	APPLICATION	NEEDLE
 <p>Standard Presser foot (T)</p>	<p>General sewing, Patchwork stitches, Decorative stitching, Smocking, Fagoting, etc.</p>		 <p>Cording foot (M) (Optional)</p>	<p>Cording</p> 	
 <p>Zipper foot (I)</p>	<p>Inserting zippers</p> 		 <p>Hemmer foot (K) (Optional)</p>	<p>Narrow hemming</p> 	
 <p>Buttonhole foot (D)</p>	<p>Buttonhole sewing</p> 		 <p>Quilt foot (Optional)</p>	<p>Darning Free embroidery Monogramming</p> 	
 <p>Button sewing foot</p>	<p>Button sewing</p> 		 <p>Straight stitch foot (P) (Optional)</p>	<p>Quilting</p> 	
 <p>Blind stitch foot (F)</p>	<p>Blind hem stitching</p> 		 <p>Gathering foot (Optional)</p>	<p>Gathering</p> 	
 <p>Overcasting foot (E)</p>	<p>Overcasting</p> 		 <p>Walking foot (Optional)</p>	<p>This foot helps to prevent uneven feeding of very difficult fabrics</p>	
 <p>Decorate stitch foot (A)</p>	<p>Satin stitch sewing</p> 				

Note:

- The twin needle is optional. It is not include with the accessories.
- When sewing with twin needle, the stitch width should be set at less than "5.0".

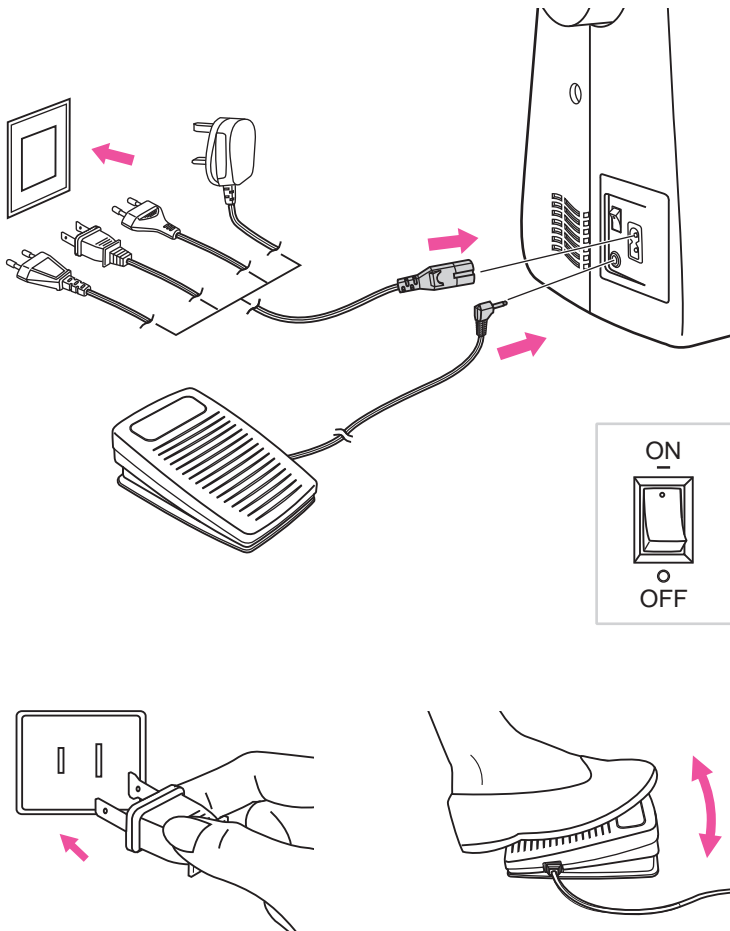

Connecting the machine

Before connecting the power supply, make sure that the voltage and frequency shown on the rating plate is conforming with your mains power.

Place the machine on a stable table.

1. Connect the power cord to the machine by inserting the 2-hole plug into the mains plug socket.
2. Connect the power line plug to the wall outlet.
Connect the foot controller plug if you use.

3. Turn on the power switch.
4. The sewing lamp will light up when the switch is turned on.
5. After switching off, it will take some time to consume the residual power in the circuitry. The light does not turn off immediately after switching off the power. This is normal phenomenon for an energy efficient appliance.

⚠ Attention:

Always make sure that the machine is unplugged from power source and the main switch is off ("O"). when the machine is not in use and before inserting or removing parts.

Polarized plug information

This appliance has a polarized plug (one blade wider than the other), to reduce the risk of electrical shock; this plug will fit in a polarized outlet only one way. If the plug does not fit fully in the outlet, reverse the plug. If it still does not fit, contact a qualified electrician to install the proper outlet. Do not modify the plug in any way.

Foot Control

With the sewing machine turned off, insert the foot control plug into its connector on the sewing machine.

Turn on the sewing machine, and then slowly depress the foot control to start sewing. Release the foot control to stop the sewing machine.

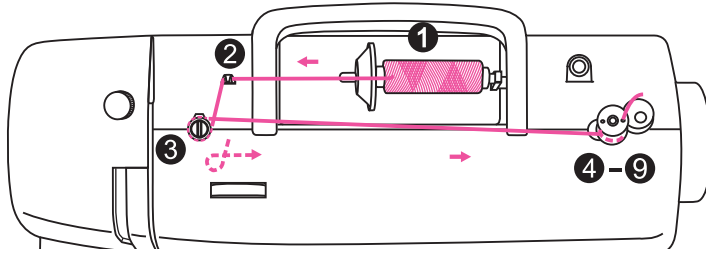

Winding the bobbin

1. Place the thread and spool cap onto the spool pin.

For smaller spools of thread, place spool cap with the small side next to the spool or use the small spool cap.

2. Snap the thread into the thread guide.

3. Wind the thread clockwise around the bobbin winder tension discs.

4. Place the thread end through one of the inner holes in the bobbin as illustrated and place empty bobbin on the spindle.

5. Push the bobbin to right.

6. Hold the thread tail securely in one hand.

7. Press on the foot control or the Start/stop button to start winding the bobbin.

8. After the bobbin has wound a few turns stop the machine and cut the thread near the hole of the bobbin. Continue filling the bobbin until it is full.

Once the spool is full, it rotates slowly. Release the pedal or stop the machine. Push the bobbin winder spindle to left.

9. Cut the thread and then remove the bobbin.

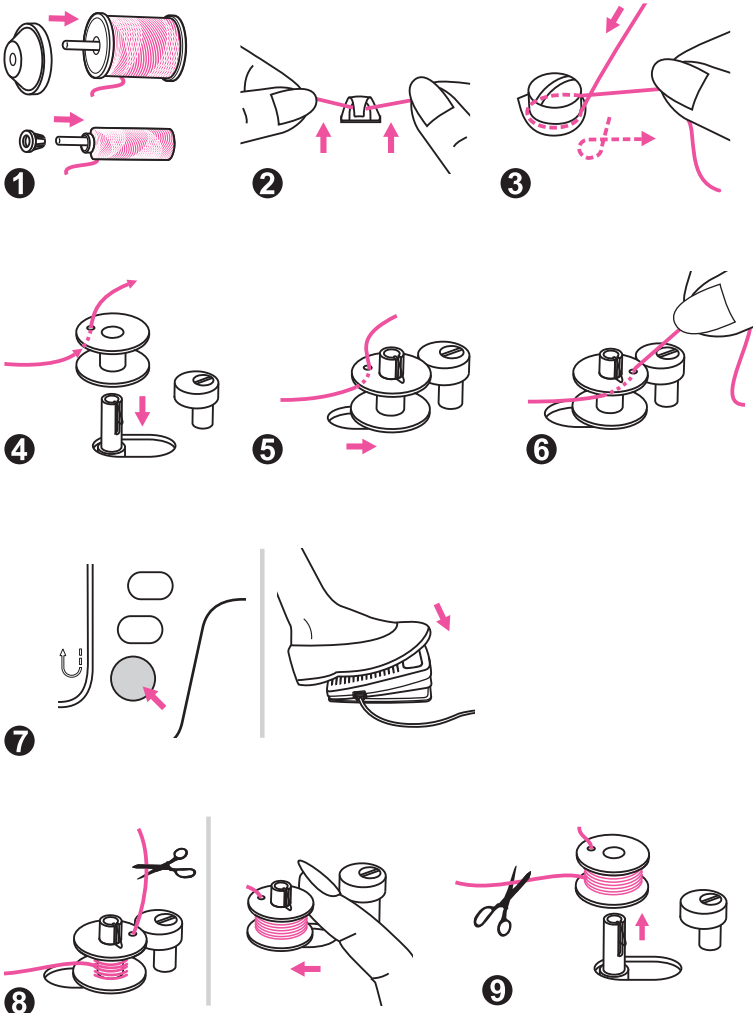

Note:

- When the bobbin winder switch is placed on the right "bobbin winding position", the buttons will not work. To start sewing, push the bobbin winder switch to the left "sewing position".
- If you find the bobbin winding the thread unevenly, you can adjust the height of the winder tension disc (3) to improve it.

Inserting the bobbin

⚠ Attention:

Turn power switch to off ("O") before inserting or removing the bobbin.

When inserting or removing the bobbin, the needle must be fully raised.

Insert the bobbin in the bobbin case with the thread running in a counterclockwise direction (arrow).

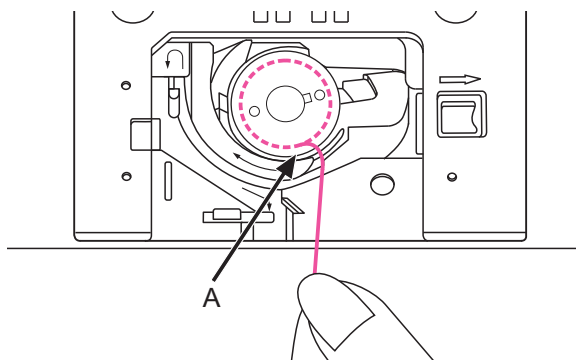
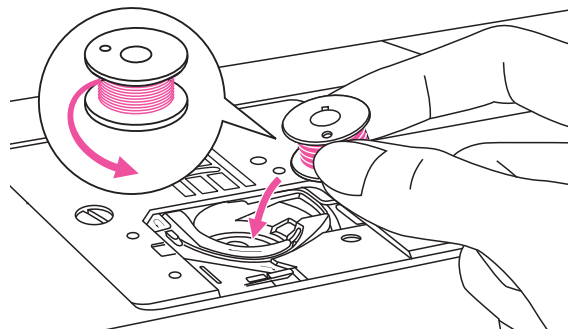

Pull the thread through the slit (A).

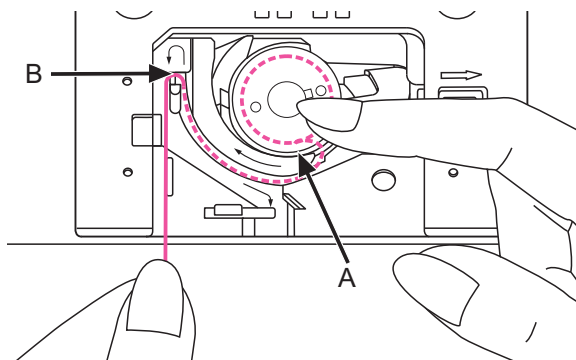

With a finger held gently on top of the bobbin.

Draw the thread at the arrow markings into the stitch plate thread guide from (A) to (B).

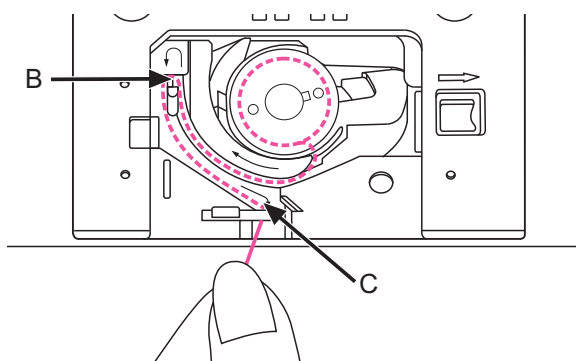

Pull the thread at the arrow markings into the stitch plate thread guide from (B) to (C). To cut off excess thread pull thread back over the cutting off blade at point (C). Close the bobbin cover plate.

Threading the upper thread

Note:

It is important to carry out the threading correctly as by not doing so several sewing problems could result.

Start by raising the needle to its highest point, and also raise the presser foot to release the tension discs.

1. Place the thread and spool cap onto the spool pin. For smaller spools of thread, place spool cap with the small side next to the spool or use the small spool cap.
2. Draw the thread from the spool through the upper thread guide.
3. Guide the thread around the thread guide pulling the thread through the pre-tension spring as illustrated.
4. Thread the tension module by passing the thread between the silver discs.
5. Then, down and around the check spring holder.
6. At the top of this movement, pass the thread from right to the left through the slotted eye of the take-up lever and then downwards again.
7. Pass the thread behind the flat, horizontal thread guide. Guide the thread through the wire loop. Pull the end of the thread through the needle from front to rear, and pull out about 10 cm of thread. Use the needle threader to thread the needle. (On the next page.)

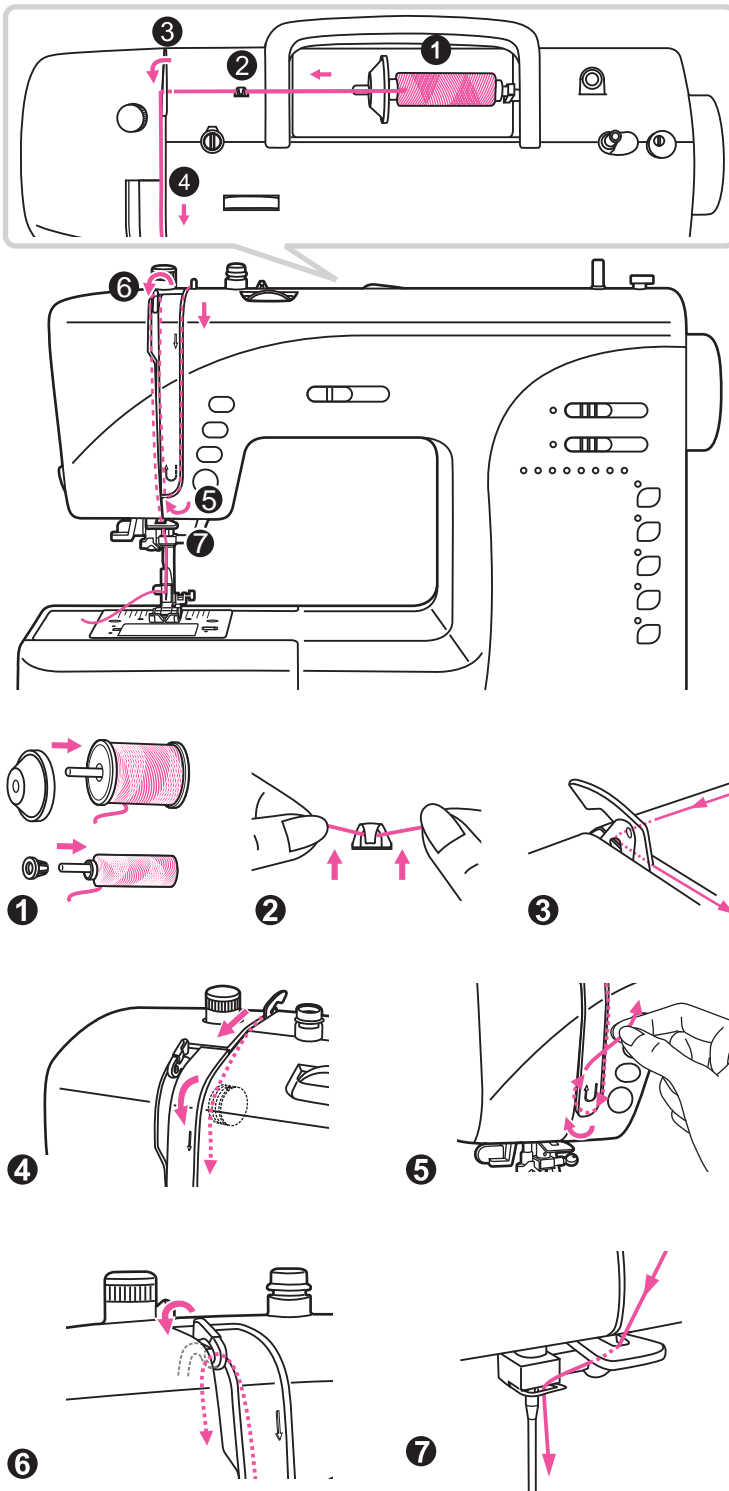

Using the needle threader

Raise the needle to its highest position and lower the presser foot.

⚠ Attention:

Turn power switch to the off position ("0").

Lower the needle threader lever slowly and draw the thread through the thread guide as illustrated and then to the right.

The needle threader automatically turns to the threading position and the hook pin passes through the needle eye.

Take the thread in front of the needle.

Hold the thread loosely and release the lever slowly. The hook will turn and pass the thread through the needle eye forming a loop.

Pull the thread through the needle eye.

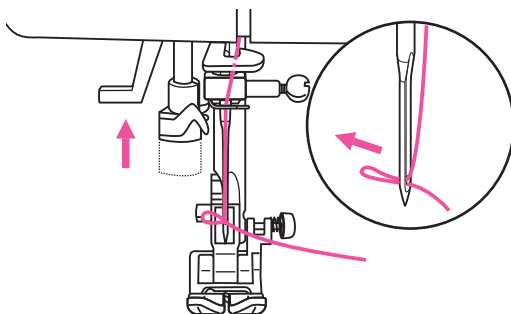
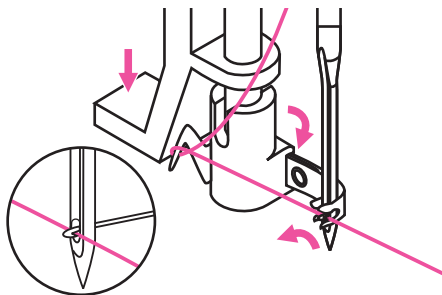
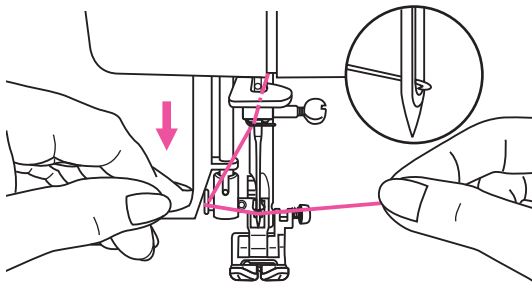
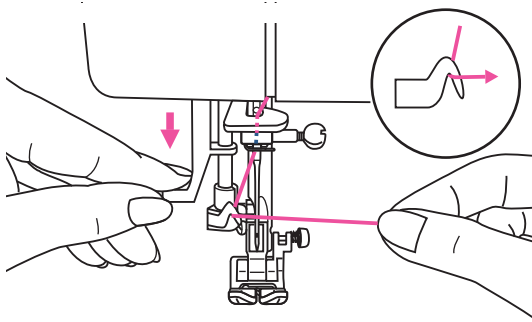

Raising up the lower thread

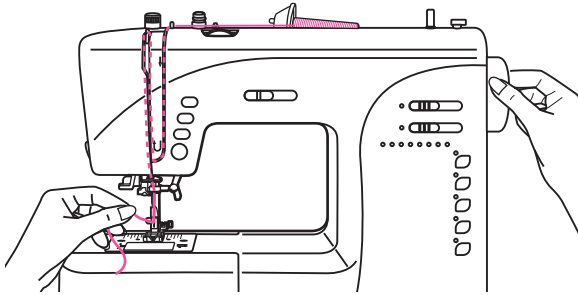

1. Hold the upper thread with the left hand. Turn the handwheel towards you (counterclockwise) lowering, then raising the needle.

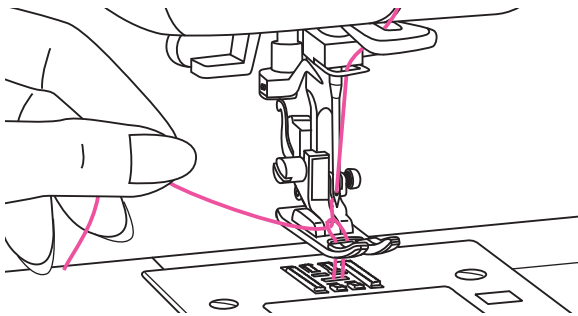

2. Gently pull on the upper thread to bring the bobbin thread up through the needle plate hole. The bobbin thread will come up in a loop.

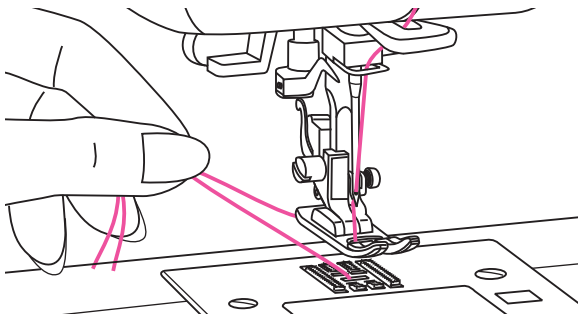

3. Pull both threads to the back under the presser foot.

Adjusting presser foot pressure

Standard presser foot pressure set at "2".

The presser foot pressure of the machine has been pre-set and no need for change unless sewing particular type of fabric (light-or-heavy weight).

If you do need to adjust the presser foot pressure, turn the presser adjusting screw by ones finger.

For sewing very thin fabric, loosen the pressure by turning the screw counterclockwise to move the screw upward and the pressure decreased. If kept turning the screw, it could be take out. By that time, just turn the screw clockwise, it could be locked back and readjust the pressure.

For heavy fabric, tighten the pressure by turning the screw clockwise to move the screw downward and the pressure increased. Once screw could not be moved any further, it has been reached the bottom, please do not turn any more.

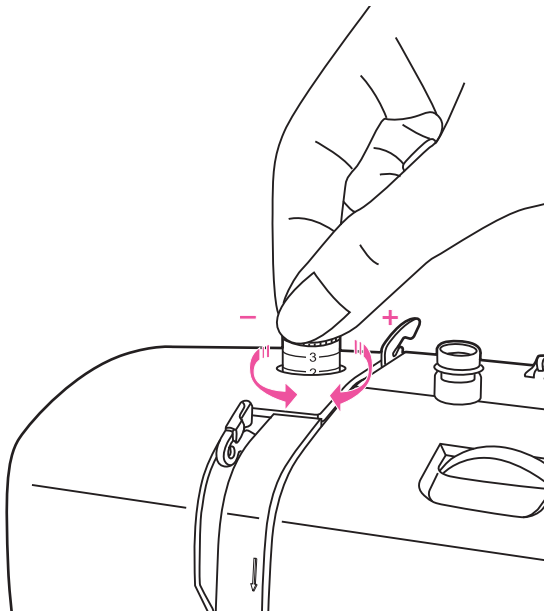

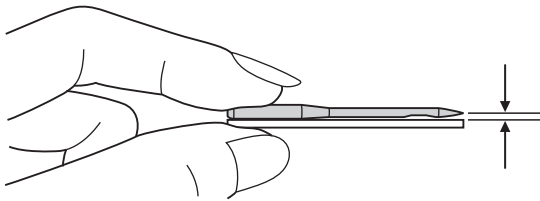
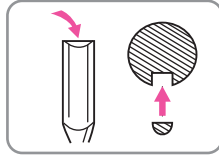
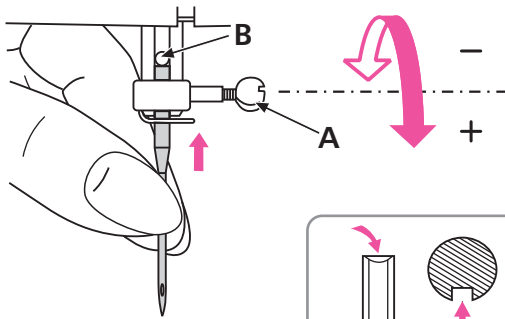

Replacing the needle



Attention:

Turn power switch to off ("O") when carrying out any of the above operations!

Change the needle regularly, especially if it is showing signs of wear and causing problems. Insert the needle following the illustrated instructions.

- A. Loosen the needle clamp screw and tighten again after inserting the new needle. The flat side of the shaft should be towards the back.
- B. Insert the needle as far up as it will go.

Needles must be in perfect condition.

Problems can occur with:

- Bent needles
- Blunt needles
- Damaged points

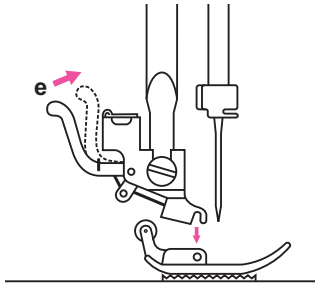

1

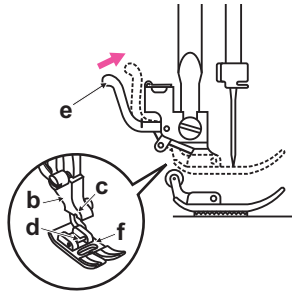

2

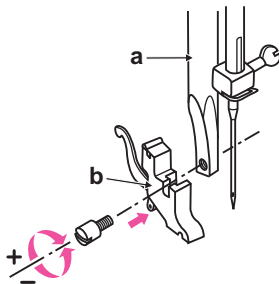

3

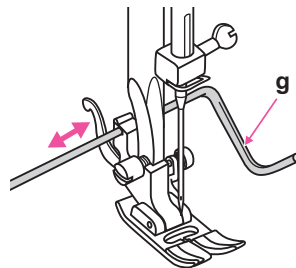

4

Changing the presser foot



Attention:

Turn power switch to off ("O") when carrying out any of the above operations!

Removing the presser foot (1)

Raise the presser foot.
Press the black lever (e) and the foot will disengage.

Attaching the presser foot (2)

Lower the presser foot holder (b) until the cut-out (c) is directly above the pin (d).
Press the black lever (e).
Lower the presser foot holder (b) and the presser foot (f) will engage automatically.

Removing and Attaching the presser foot holder (3)

Raise the presser foot bar (a).
Remove and Attach the presser foot holder (b) as illustrated.

Attaching the edge/quilting guide (4)

Attach the edge/quilting guide (g) in the slot as illustrated.
Adjust according to need for hems, pleats, etc.

Two-step presser foot lifter

The presser foot lifter raises and lowers your presser foot.

When sewing several layers or thick fabrics, the presser foot can be raised a second stage for easy positioning of the work.

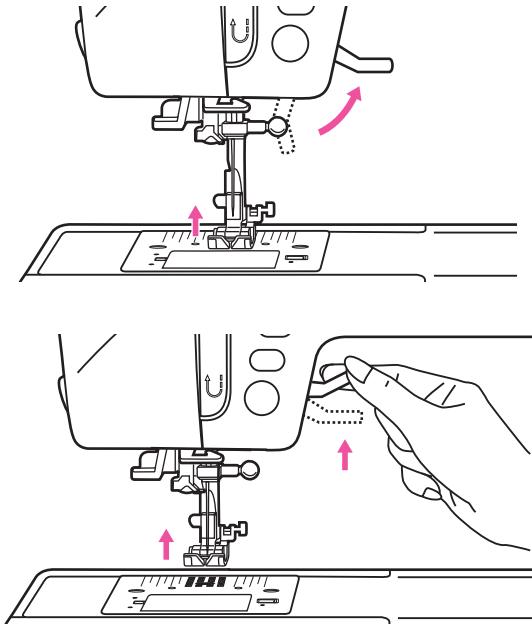

To raise or drop the feed dogs

With the sewing table off the machine, the feed dog adjustment lever can be seen on the base in back of the sewing machine.

Sliding the lever to the "▲▲▲" (b) will lower the feed dog, for example during button sewing. If you wish to continue sewing normally, slide the lever to the "▲▲▲" (a) in order to raise the feed dogs.

The feed dog will not rise up if you do not turn the handwheel, even if the lever is slid to the right. Make a complete turn to raise the feed dogs.

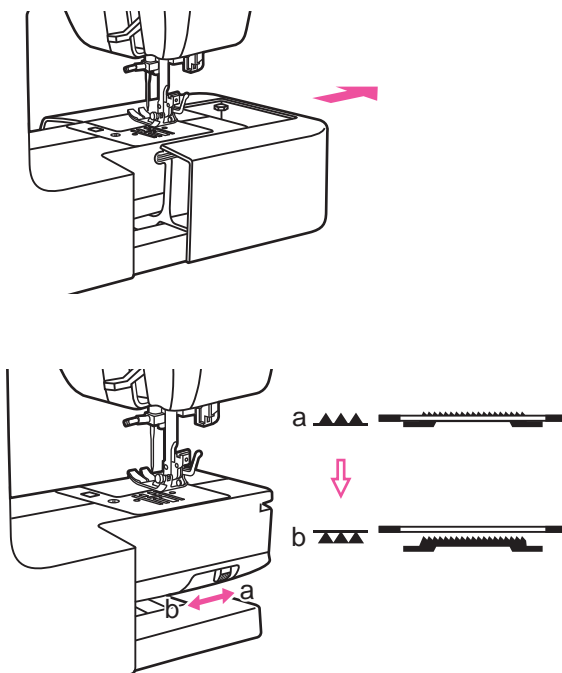

Matching needle/ fabric/ thread

Needle, fabric, thread selection guide

NEEDLE SIZE	FABRICS	THREAD
9-11 (70-80)	Lightweight fabrics-thin cottons, voile, serge, silk, muslin, Qiana, interlocks, cotton knits, tricot, jerseys, crepes, woven polyester, shirt & blouse fabrics.	Light-duty thread in cotton, nylon, polyester or cotton wrapped polyester.
11-14 (80-90)	Medium weight fabrics-cotton, satin, sailcloth, double knits, lightweight woollens.	Most threads sold are medium size and suitable for these fabrics and needle sizes. Use polyester threads on synthetic materials and cotton on natural woven fabrics for best results. Always use the same thread on top and bottom.
14 (90)	Medium weight fabrics-cotton duck, woolen, heavier knits, terrycloth, denims.	
16 (100)	Heavyweight fabrics-canvas, woollens, outdoor tent and quilted fabrics, denims, upholstery material (light to medium).	
18 (110)	Heavy woollens, overcoat fabrics, upholstery fabrics, some leathers and vinyls.	Heavy duty thread, carpet thread.

Note:

- In general, fine threads and needles are used for sewing fine fabrics, and thicker threads are used for sewing heavy fabrics.
- Always test thread and needle size on a small piece of fabric which will be used for actual sewing.
- Use the same thread for needle and bobbin.
- Use a backing for fine or stretchy fabrics.

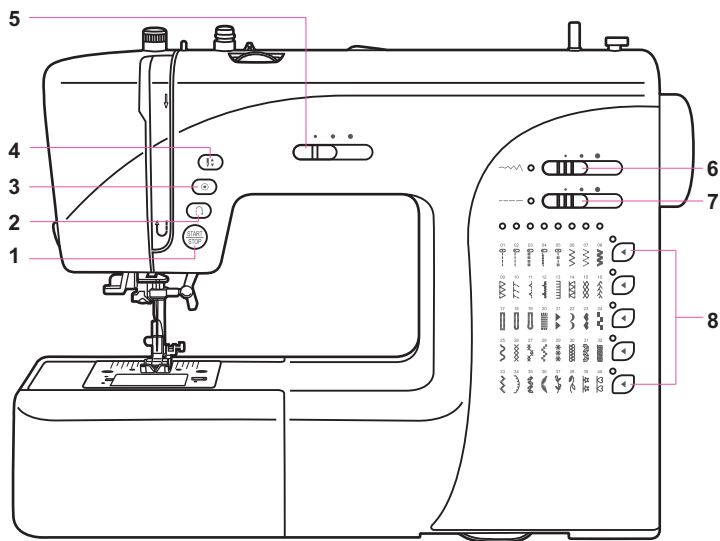

Buttons of the machine

1. Start/stop button
2. Reverse button
3. Auto-lock/ Stop button
4. Needle up/ down position button
5. Speed limiting adjustment lever
6. Stitch width adjustment button
7. Stitch length adjustment button
8. Pattern selection buttons

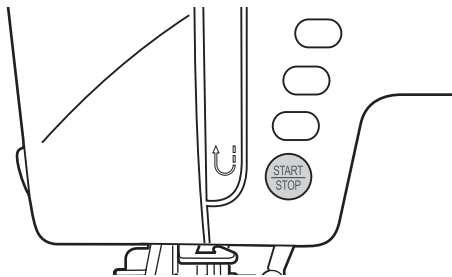

Start/stop button (1)

The machine will start running when Start/stop button is pressed and will stop when pressed the second time. The machine will rotate slowly at the beginning of the sewing.

The sewing speed can be controlled by the speed limiting adjustment lever.

This way you may operate the machine without foot control.

Color of button indicates machine status.

Green: Ready to start and/or while sewing.

Red: Not ready to start.

(Presser foot is not lowered. The thread is twisted or jammed.)

Orange: Machine is in bobbin winding condition.

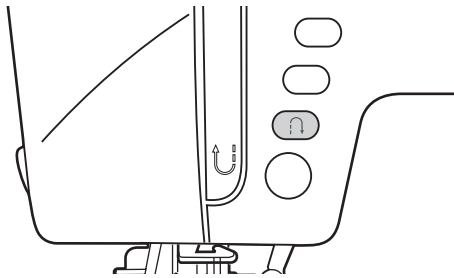

Reverse button (2)

When the patterns 01-16, 21-40 are selected, the machine will sew reverse or a reinforcement stitch at a low speed if the reverse button is pressed. The machine will sew forward after the button is released.

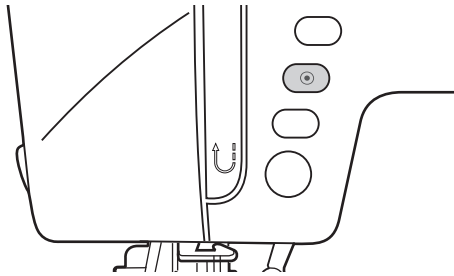

Auto-Lock/Stop button (3)

When the patterns 01-16 are selected, the machine will immediately sew 3 locking stitches when the Auto-lock button is pressed, then automatically stop.

When the patterns 21-40 are selected, press the Auto-stop button, the machine will sew 3 locking stitches at the end of the current pattern and automatically stop.

The function will be cancelled if you press the button once again or select another pattern.

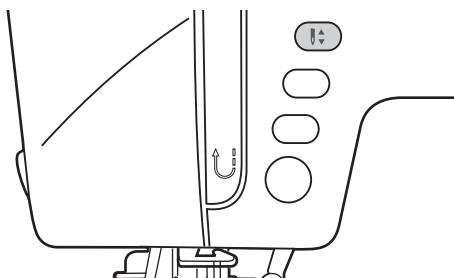

Needle up/ down position button (4)

With the Needle up/ down position button, you decide whether the needle shall stop in the up position or in the material when you stop sewing.

During sewing, press the button the machine will stop and the needle stop at the opposite position.

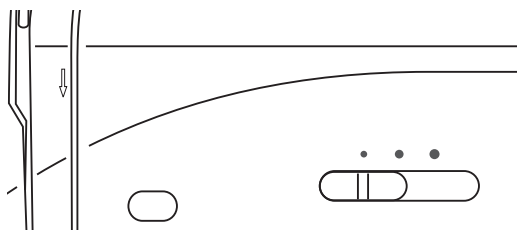

Speed limiting adjustment lever (5)

The speed limiting adjustment lever can control the sewing speed. To increase the speed, slide the lever to the right, to decrease the sewing speed, slide the lever to the left.

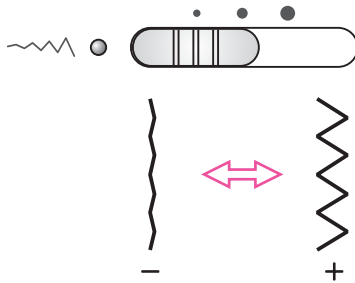

Stitch width adjustment lever (6)

When you select a stitch, the machine will automatically set the recommended stitch width. The stitch width can be regulated by sliding the stitch width adjustment lever.

Auto settings are easily determined by sliding the lever. The LED indicator next to the lever will blink and beep 1 time to indicate the setting is at the auto position.

When the setting is at the auto position, you can manually change the width according to your preference. Starting at the auto position, slide the lever to the left or right to locate each potential adjustment. At each manual adjustment point, the LED will blink 3 times and beep once.

For a narrower stitch, slide the lever to left. For a wider stitch, slide the lever to right. The stitch width can be adjusted between "0.0-7.0". Certain stitches have limited stitch widths.

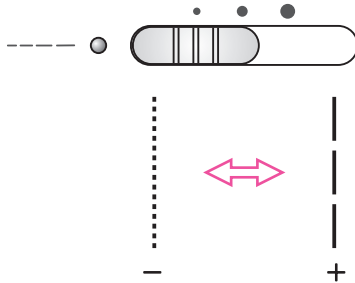

Stitch length adjustment lever (7)

When you select a stitch, the machine will automatically set the recommended stitch length. The stitch length can be regulated by sliding the stitch length adjustment lever.

Auto settings are easily determined by sliding the lever. The LED indicator next to the lever will blink and beep 1 time to indicate the setting is at the auto position.

When the setting is at the auto position, you can manually change the length according to your preference. Starting at the auto position, slide the lever to the left or right to locate each potential adjustment. At each manual adjustment point, the LED will blink 3 times and beep once.

To shorten the stitch length, slide the lever to left. For a longer stitch length, slide the lever to right. The stitch length can be adjusted between "0.0-4.5". Certain stitches have limited lengths.

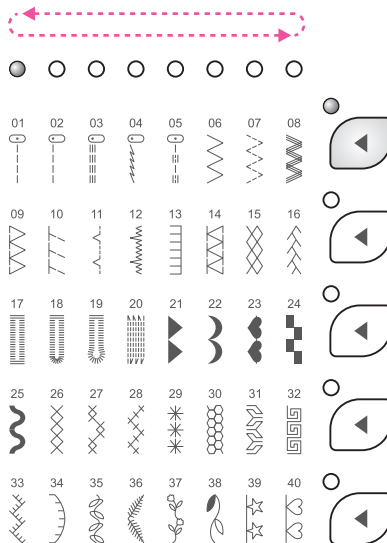









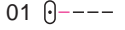



























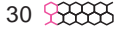



Pattern selection buttons (8)

Turn on the power switch and the LED indicator above the straight stitch pattern will be lit.

To select other patterns, press the pattern selection button to the right of the row that contains your desired pattern. Stop when the LED indicator above your pattern is lit.

Pattern chart

Stitch Pattern		Width (mm)		Length (mm)		Presser Foot	Functions	
		Auto	Manual	Auto	Manual		Reverse	Auto-lock
Utility stitches	01 	3.5	0.0~7.0	2.5	0.0~4.5	T	*	*
	02 	0.0	0.0~7.0	2.5	0.0~4.5	T	*	*
	03 	0.0	0.0~7.0	2.5	1.0~3.0	T	*	*
	04 	1.0	1.0~6.0	2.5	1.0~3.0	T	*	*
	05 	3.5	0.0~7.0	2.5	1.5~3.0	T	*	*
	06 	5.0	0.0~7.0	2.0	0.3~4.5	T	*	*
	07 	5.0	2.0~7.0	1.0	0.3~4.5	T	*	*
	08 	5.0	2.5~7.0	2.5	1.0~3.0	T	*	*
	09 	5.0	3.5~7.0	2.5	1.0~3.0	E	*	*
	10 	5.0	2.5~7.0	2.5	1.0~3.0	T	*	*
	11 	3.5	2.5~7.0	2.0	0.5~4.5	F	*	*
	12 	3.5	2.5~7.0	1.0	0.5~4.5	F	*	*
	13 	3.5	2.5~7.0	2.5	1.5~3.0	T	*	*
	14 	5.0	2.5~7.0	2.5	1.0~3.0	T	*	*
	15 	7.0	2.5~7.0	2.5	1.0~3.0	A	*	*
16 	5.0	2.5~7.0	2.5	1.0~3.0	A			
Buttonhole stitches	17 	5.0	3.0~7.0	0.5	0.3~1.0	D		
	18 	5.0	3.0~5.5	0.5	0.3~1.0	D		
	19 	7.0	5.5~7.0	0.5	0.3~1.0	D		
Darning stitch	20 	7.0	3.5~7.0	2.0	1.0~2.0	D		
Satin stitches	21 	7.0	2.5~7.0	0.5	0.3~1.0	A	*	*
	22 	7.0	2.5~7.0	0.5	0.3~1.0	A	*	*
	23 	7.0	2.5~7.0	0.5	0.3~1.0	A	*	*
	24 	7.0	2.5~7.0	0.5	0.3~1.0	A	*	*
	25 	7.0	2.5~7.0	0.5	0.3~1.0	A	*	*
Cross stitches	26 	5.0	2.5~7.0	1.0	1.0~3.0	A	*	*
	27 	4.0	3.0~7.0	1.0	1.0~3.0	A	*	*
	28 	6.0	3.0~7.0	3.0	1.0~3.0	A	*	*
Decorative stitches	29 	5.0	3.0~7.0	2.0	1.5~3.0	A	*	*
	30 	7.0	3.0~7.0	2.0	1.0~3.0	T	*	*
	31 	7.0	2.5~7.0	2.0	1.0~3.0	T	*	*
	32 	5.0	2.5~7.0	2.5	1.5~3.0	T	*	*
	33 	7.0	2.5~7.0	1.5	1.0~3.0	A	*	*
	34 	7.0	2.5~7.0	2.5	1.0~4.5	T	*	*
	35 	5.0	3.5~7.0	1.0	1.0~3.0	A	*	*
	36 	7.0	2.5~7.0	3.0	2.0~3.0	A	*	*
	37 	7.0	3.5~7.0	1.5	1.5~3.0	A	*	*
	38 	7.0	2.5~7.0	2.5	1.5~3.0	A	*	*
	39 	5.0	2.5~7.0	2.0	1.0~3.0	T	*	*
	40 	5.0	2.5~7.0	2.0	1.0~3.0	T	*	*

The portion marked in colored on the chart below shows the one unit of each pattern.

Thread tension

- Basic thread tension setting: "4"
- To increase the tension, turn the dial to the next number up. To reduce the tension, turn the dial to the next number down.
- Proper setting of tension is important to good sewing.
- For all decorative sewing you will always obtain a nicer stitch and less fabric puckering when the upper thread appears on the bottom side of your fabric.

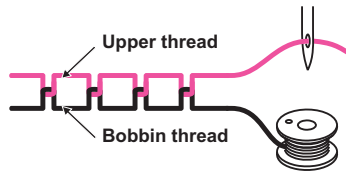
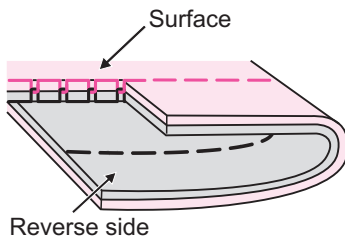
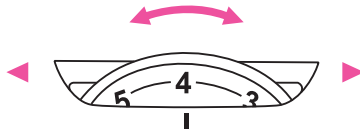

Normal thread tension for straight stitch sewing.

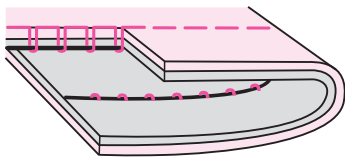

Thread tension is too loose for straight stitch sewing. Turn dial to higher number.

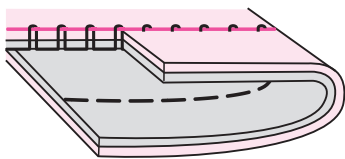

Thread tension is too tight for straight stitch sewing. Turn dial to lower number.

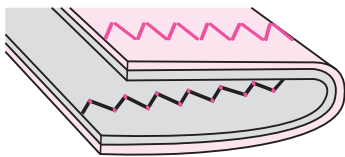

Normal thread tension for zig zag and decorative sewing.

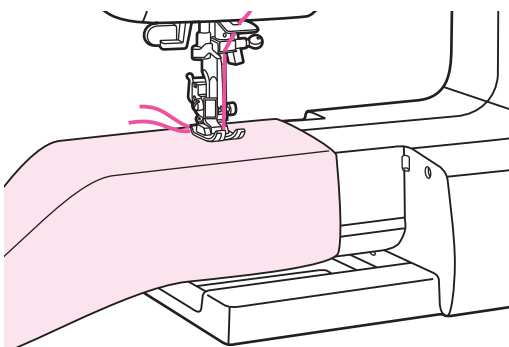
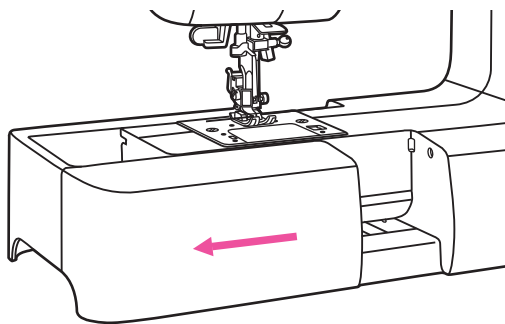
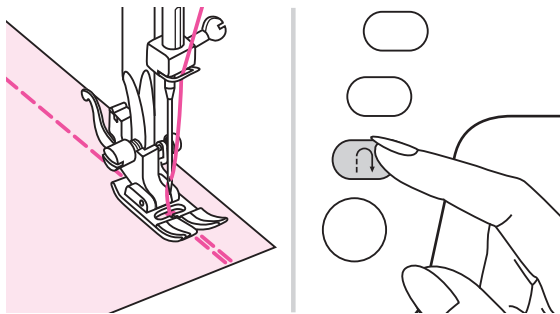
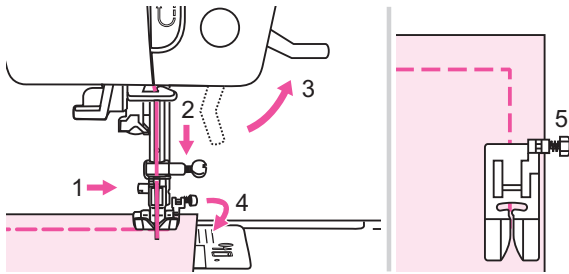

Useful skills

Sewing corners

1. Stop the sewing machine when you reach a corner.
2. Lower the needle into the fabric manually or by pressing the needle up/down button once.
3. Raise the presser foot.
4. Use the needle as a pivot and turn the fabric.
5. Lower the presser foot and resume sewing.

Reverse

Reverse stitching is used to secure the threads at the beginning and at the end of a seam.

Press the reverse button and sew 4-5 stitches.

The machine will sew forward when the button is released.

Free arm

Free-arm sewing is convenient for sewing tubular areas such as pant hems and cuffs.

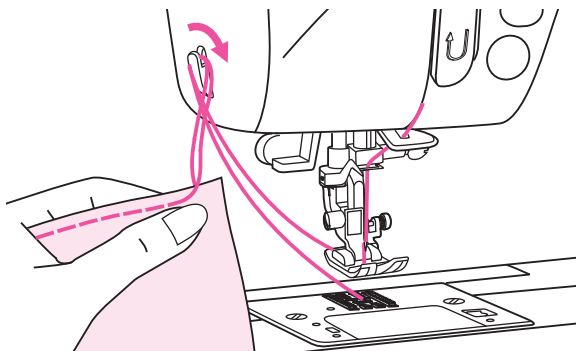
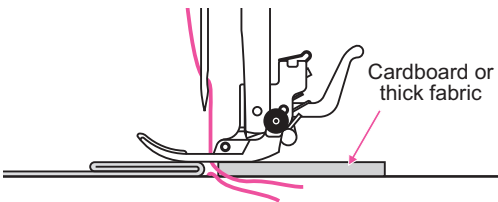
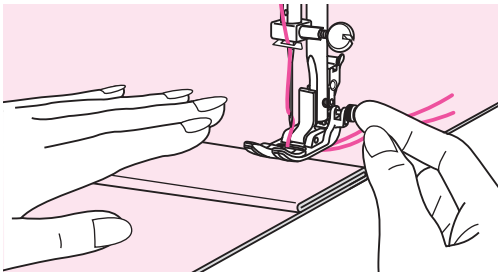
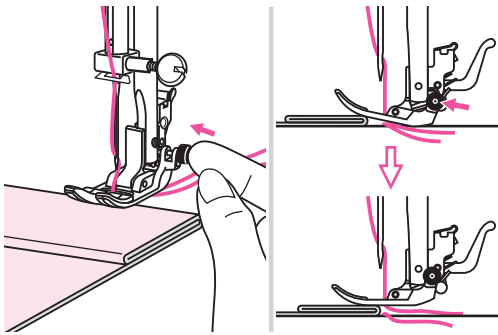

Sewing on heavy fabrics

The black button on the right side of the presser foot will lock the presser foot in a horizontal position if you push it in before lowering the presser foot. This ensures even feeding at the beginning of a seam and helps when sewing multiple layers of fabric such as sewing over seams when hemming jeans.

When you reach the point of an increased thickness, lower the needle and raise the presser foot. Press the toe of the foot and push in the black button, then lower the foot and continue sewing.

The black button releases automatically after sewing few stitches.

You also can place another piece of fabric with the same thickness at the back of the seam. Or support the presser foot while feeding by hand and sewing toward the folded side.

Cutting the thread

Raise the presser foot. Remove the fabric, draw the threads to the left side of the face cover and cut using the thread cutter.

The threads are cut at the proper length to start the next seam.

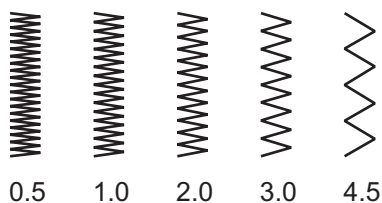
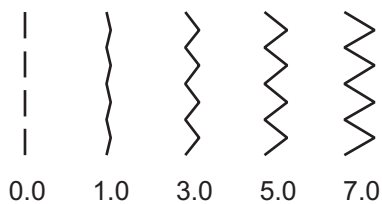
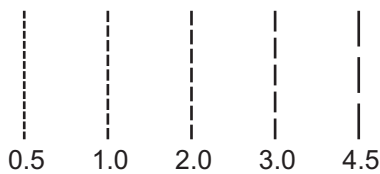
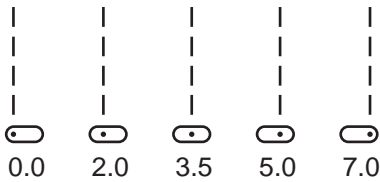
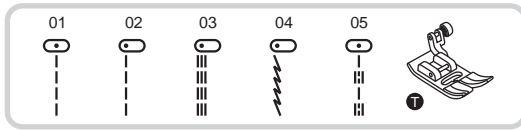

Straight stitches and needle position

Changing the needle position

These settings apply only to patterns 01-05. The pre-set position is "3.5", center position. When you slide the stitch width adjustment lever to the left, the needle position will move to the left. When you slide the stitch width adjustment lever to the right, the needle position will move to the right.

Changing the stitch length

To shorten the stitch length, slide the stitch length adjustment lever to the left. For a longer stitch length, slide the stitch length adjustment lever to the right.

Generally speaking, the thicker the fabric, thread and needle, the longer the stitch should be.

Zigzag stitches

Adjusting the stitch width

The maximum zigzag stitch width for zigzag stitching is "7.0"; however, the width can be reduced on any patterns. The width increases as you slide the stitch width adjustment lever from "0.0-7.0".

Adjusting the stitch length

The density of zigzag stitches increase as the setting of stitch length approaches "0.3".

Neat zigzag stitches are usually achieved at "1.0-2.5".

Closed up zigzag stitches (close together) are referred to as a satin stitch.

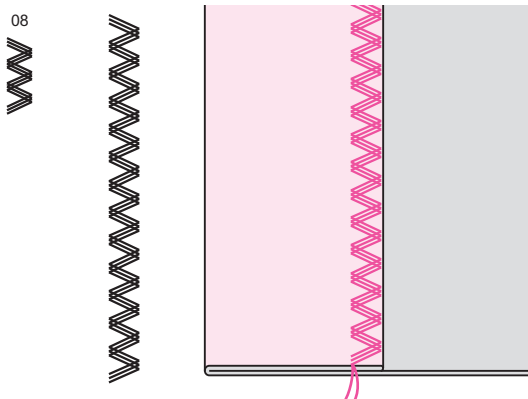
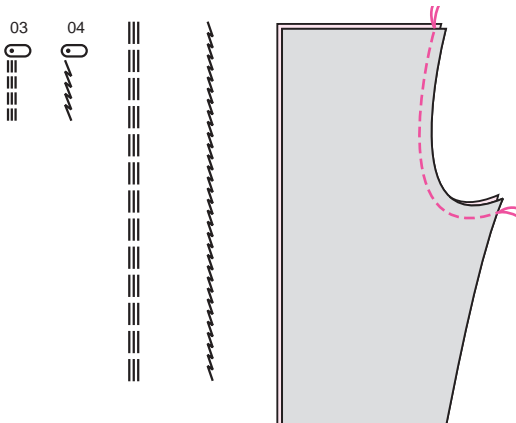
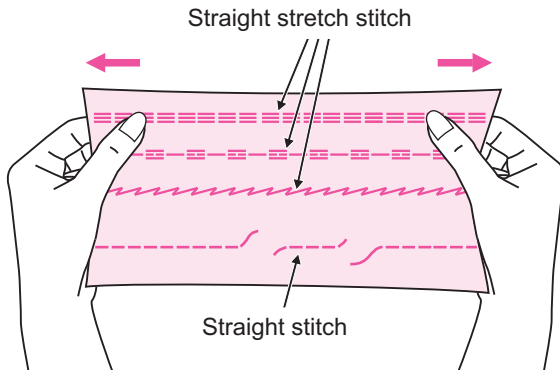
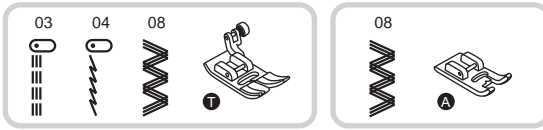

Stretch stitches

Use this stitch with knitted, tricot or other stretchy fabrics. The stitch enables your seam to stretch without breaking the thread.

Good for easy to ravel and knit fabrics. It is good for joining durable fabric such as denims.

These stitches can also be used as a decorative top stitch.

Straight stretch stitch is used to add triple reinforcement to stretch and hardwearing seams.

Triple zigzag stretch stitch is suitable for firm fabrics like denim, poplin, duck, etc.

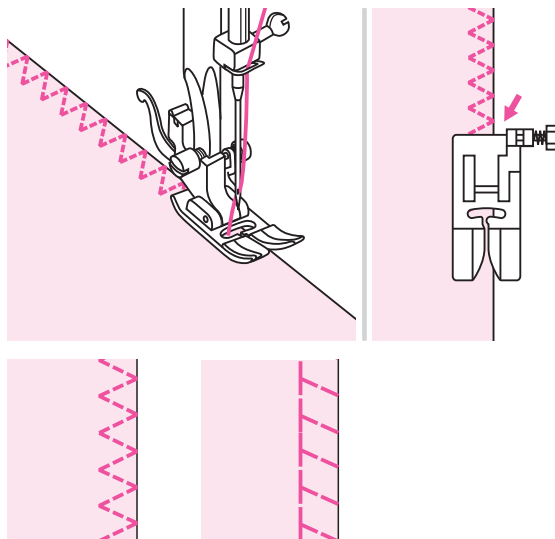
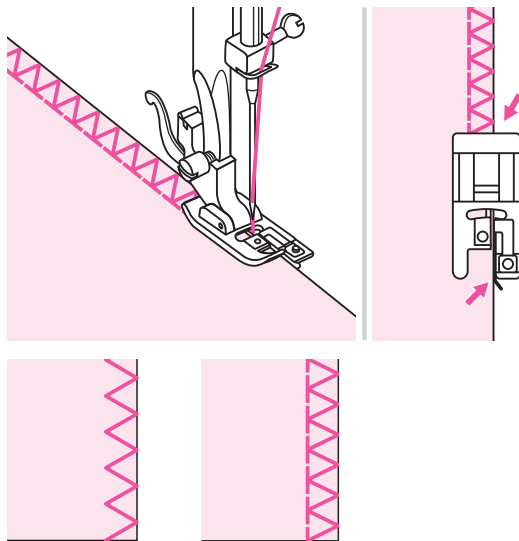

Overcasting stitches

Sewing overcasting stitches along the edges of fabric to prevent them from fraying.

Using the overcasting foot

Change the presser foot to the overcasting foot (E).

Sew the fabric with the fabric edge against the guide of the overcasting foot.

⚠ Attention:

The overcasting foot should be used to sew with patterns 05 and 08 only and do not set the stitch width narrower than "5.0". It is possible that needle could hit the presser foot and break when sewing other patterns and width.

Using the standard presser foot

Change the presser foot to the standard presser foot (T).

Sewing the overcasting along the edge of the fabric so that the needle drops over the edge of the fabric on the right side.

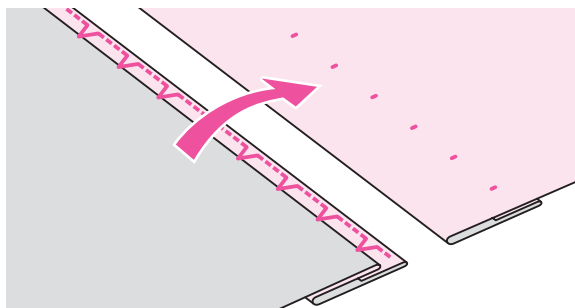
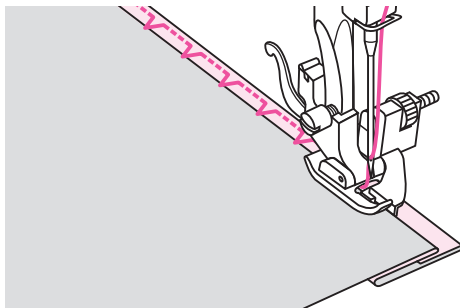
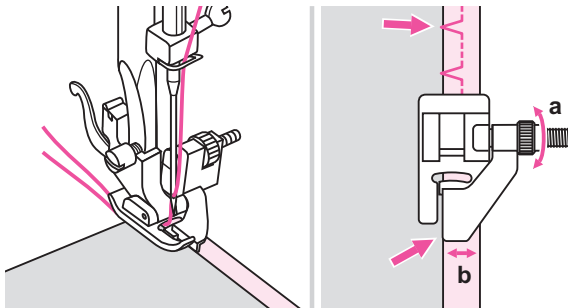
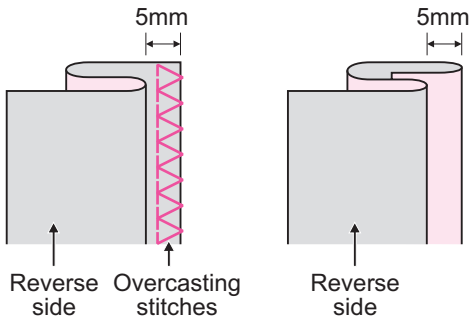

Blind hem/ Lingerie stitch

Secure the bottoms of skirts and pants with a blind hem, this stitch will sew without stitches showing on right side of fabric.

11: Blind hem/lingerie for firm fabrics

12: Blind hem for stretch fabrics

Note:

It takes practice to sew blind hems. Always make a sewing test first.

Fold the fabric as illustrated with the wrong side uppermost.

Place the fabric under the foot. Turn the handwheel forwards by hand until the needle swings fully to the left. It should just pierce the fold of the fabric. If it does not, adjust the stitch width accordingly.

Adjust the guide (b) by turning the knob (a) so that the guide just rests against the fold.

Sew slowly, guiding the fabric carefully along the edge of the guide.

Turn over the fabric.

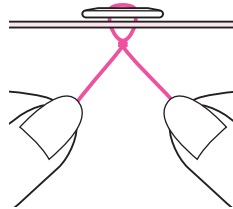
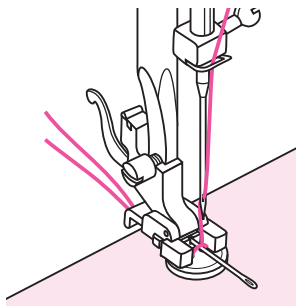
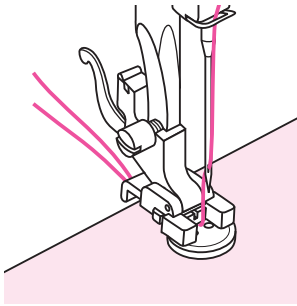
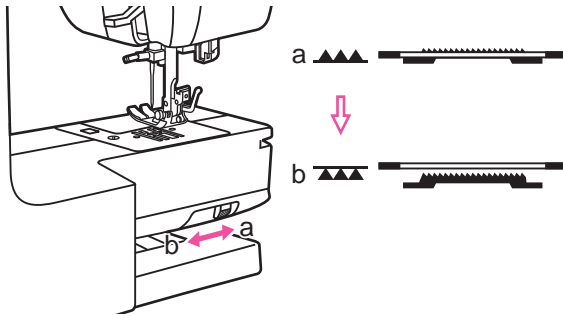
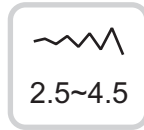
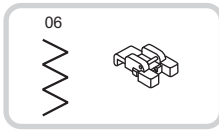

Button sewing

Change the presser foot to the button sewing foot.

Move the drop feed control to "▲▲▲" to lower the feed dogs.

Position the work under the foot. Place the button in the desired position, lower the foot.

Select zig zag pattern. Adjust the stitch width to "2.5-4.5" according to the distance between the two holes of the button.

Turn the handwheel to check that the needle goes cleanly into the left and right holes of the button.

Before sewing, press the Auto-lock button to sew reinforcement stitches automatically at the beginning and at the end of the stitch. If a shank is required (ex. sew on coats or jackets), place a darning needle on top of the button and sew. Pull end of the upper thread to the wrong side of the fabric, then tie it with the bobbin thread.

For buttons with 4 holes, sew through the front two holes first, push work forward and then sew through the back two holes.

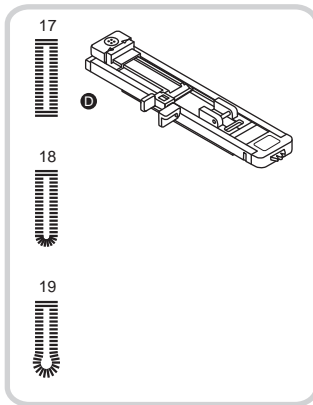

3.0~7.0	0.3~1.0

3.0~5.5	0.3~1.0

5.5~7.0	0.3~1.0

Buttonhole stitching

Buttonhole sewing to match the size of the button is possible.

For stretch fabric or thin fabric, it is recommended to use a stabilizer for a better buttonhole finish.

- 17 For thin or medium fabric
- 18 For horizontal holes on blouses or shirts made from thin or medium fabric
- 19 For suits or overcoats

Note:

Before sewing a buttonhole on your project, practice on a scrap piece of the same type of fabric.

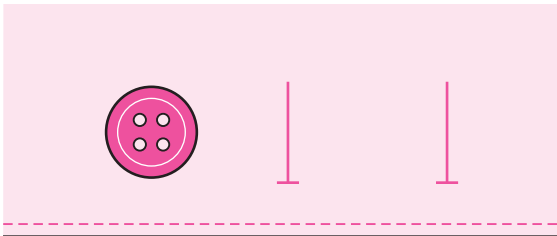

Mark the positions of the buttonhole on the fabric.

The maximum buttonhole length is 3cm (1 3/16 inch).
(Total of diameter + thickness of button.)

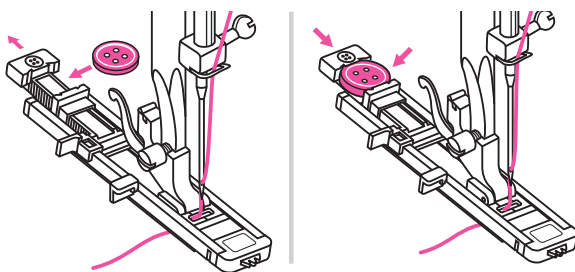

Attach the buttonhole foot, then pull out the button holder plate and insert the button.

The size of the buttonhole is determined by the button inserted in the button plate.

The thread should be passed through the hole in the presser foot, then be placed under the foot.

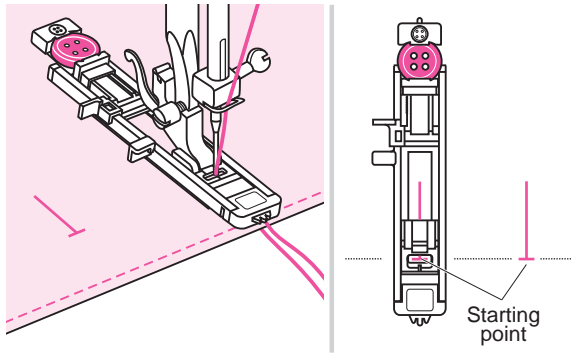

Select the buttonhole stitch.
Adjust the stitch width and the stitch length to the desired width and density.
Position the fabric under the presser foot with the front end of the buttonhole mark aligned with the center line on the buttonhole foot.

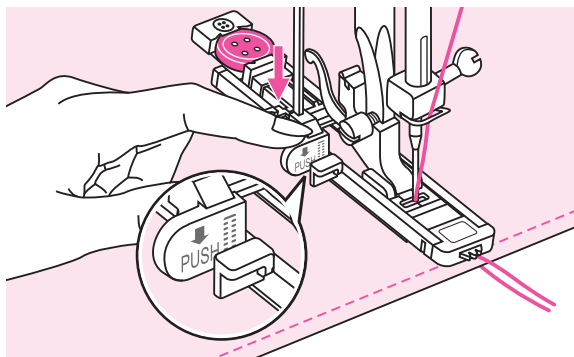

Pull the buttonhole lever all the way down and position it behind the bracket on the buttonhole foot.

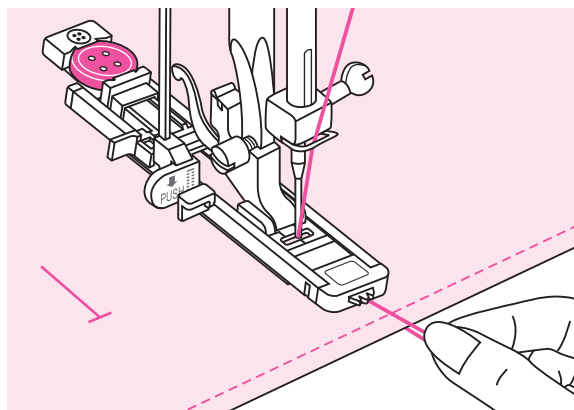

While lightly holding the end of upper thread and start sewing.

➡ Note:

Gently feed the fabric by hand.
Before stopping, the machine will automatically sew a reinforcement stitch after the buttonhole is sewn.

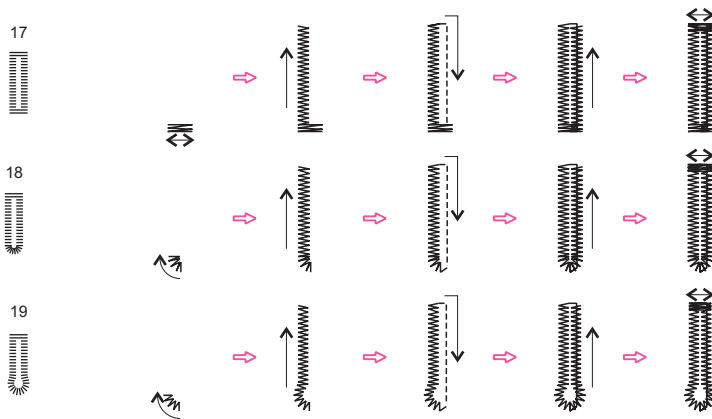

Buttonholes are sewn from the front of the presser foot to the back, as shown.

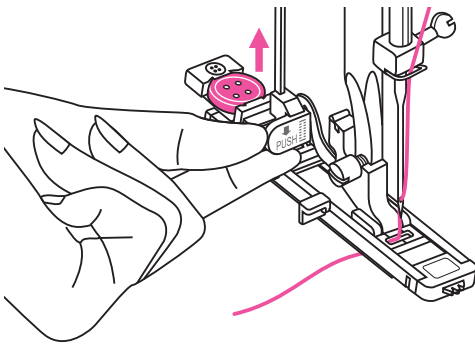

Raise the presser foot and cut thread. To restart the same buttonhole at the beginning, raise the presser foot to return to the starting position.

! Attention:

After sewing the buttonholes, raise the buttonhole lever all the way up to its original position for other sewing.

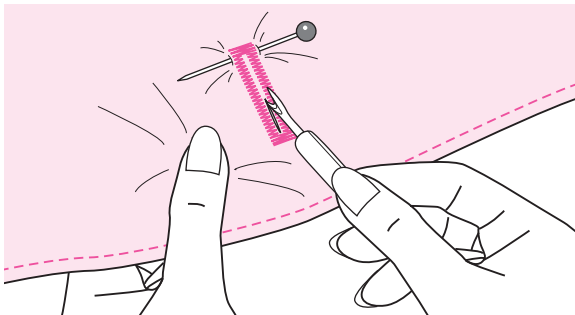

Cut the center of the buttonhole being careful not to cut any stitches on either side. Use a pin as a stopper at the bar tack so you do not cut too much.

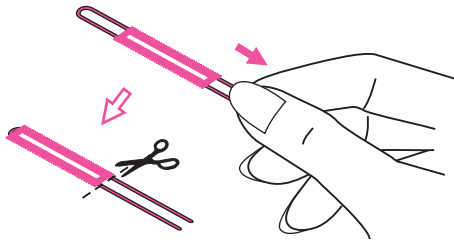
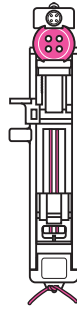
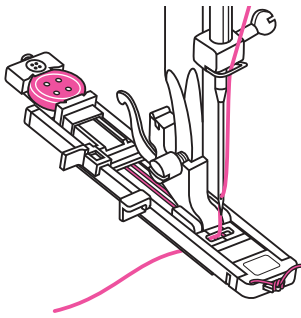

Making a buttonhole on stretch fabrics

When sewing buttonholes on stretch fabric, hook heavy thread or cord under the button-hole foot.

Attach the buttonhole foot and hook the gimp thread onto the back of the presser foot.

Bring the two gimp thread ends to the front of the foot and insert them into the grooves, then temporarily tie them there. Lower the presser foot and start sewing.

Set the stitch width to match the diameter of the gimp thread.

Once sewing is completed, pull the gimp thread gently to remove any slack, then trim off any excess.

➔ Note:

It is suggested that you use interfacing on the backside of the fabric.

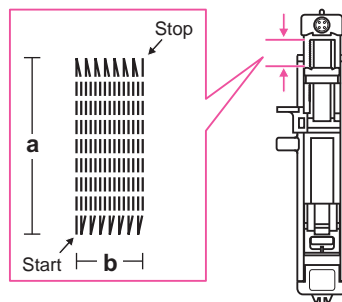
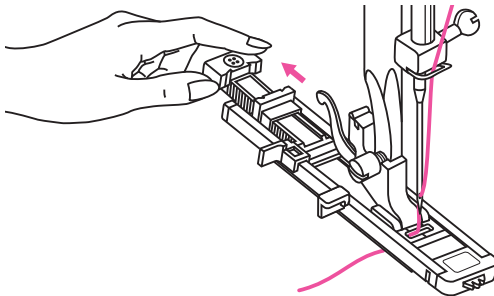
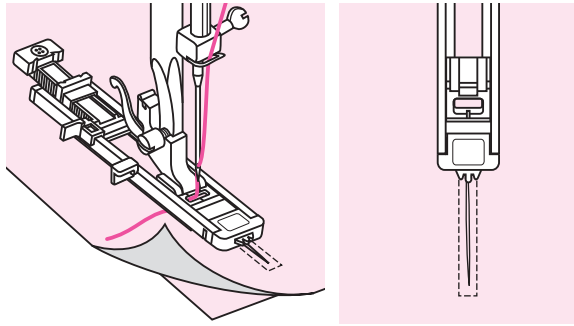
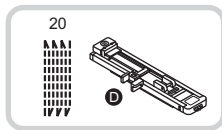

Darning stitch

Darning a small hole or a tear before it becomes larger can save a garment. Choose a fine thread in a color as close to your garment as possible.

Select pattern 20 to get the darning stitch.

Change the presser foot to the buttonhole foot.

Baste the upper fabric and the under fabric together. Select the needle position. Lower the presser foot over the center of the tear.

Pull the button holder to rear.

Set the button guide plate on buttonhole foot to the desired length.

The size of one darn cycle is variable.

However, the maximum stitch length is 2.6cm (1 inch) and the maximum stitch width is 7mm (9/32 inch).

a. The length of sewing.

b. The width of sewing.

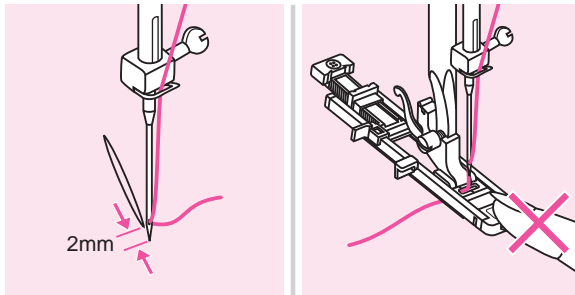

Position the fabric so that the needle is 2mm (1/16 inch) in front of the area to be darned, and then lower the presser foot lever.

Note:

When lowering the presser foot, do not push in the front of the presser foot, otherwise the darning will not be sewn with the correct size.

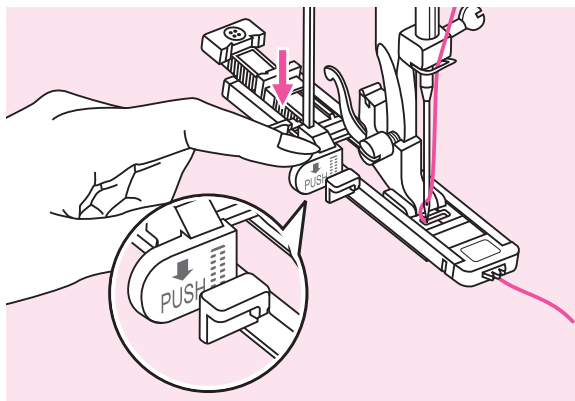

Pass the upper thread down through the hole in the presser foot. Pull down the buttonhole lever. The buttonhole lever is positioned behind the bracket on the buttonhole foot.

Gently hold the end of the upper thread in your left hand, and then start sewing.

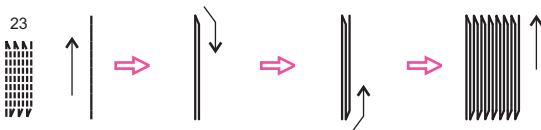

Darning stitches are sewn from the front of the presser foot to the back, as shown.

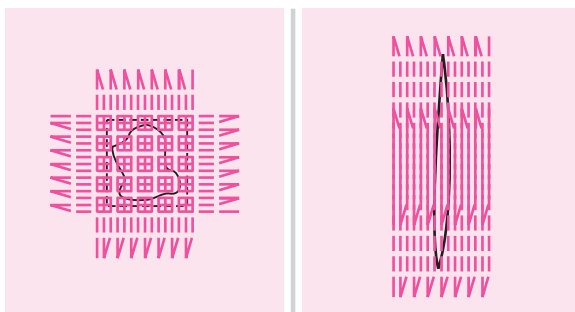

If the sewing range is too big to sew, then we suggest you can sew several times (or cross sew) to get better sewing result.

Attention:

After sewing the darning stitches, raise the buttonhole lever all the way up to its original position for other sewing.

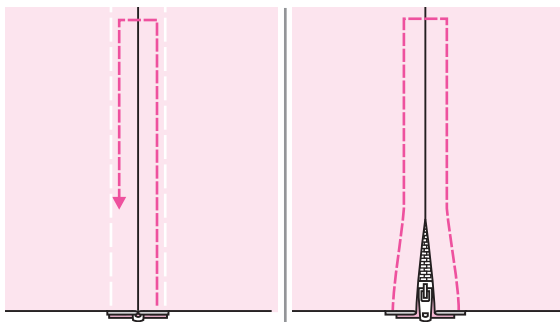
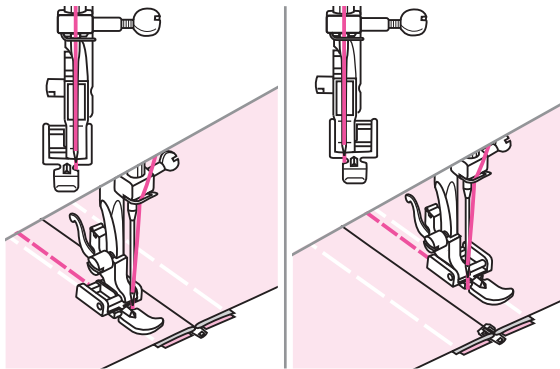
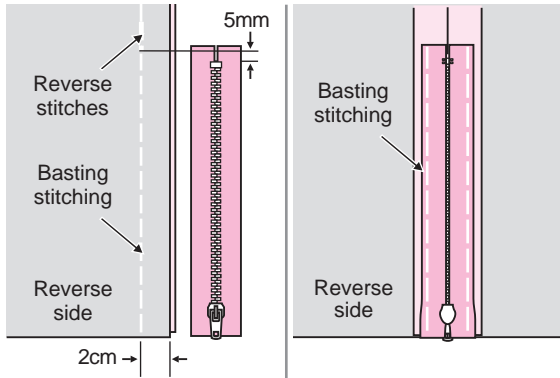
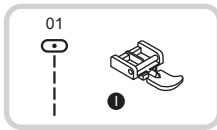

Zipper insertion

This foot can be set to sew on each side of the zipper, the The edge of the foot guides the zipper to ensure straight placement.

⚠ Attention:

Zipper foot should be used for sewing width center needle position straight stitch only. It is possible that needle could hit the presser foot and break when sewing other patterns.

Inserting a centered zipper

- Place the right sides of the fabric together. Sew a bottom seam 2cm from the right edge to the zipper bottom stop position. Sew a few stitches in reverse to lock. Increase the stitch length to maximum, set the tension below 2, and baste the remaining length of the fabric.

- Press open the seam allowance.

Place the zipper face down on the seam allowance with the teeth against the seam line. Baste the zipper tape.

- Attach the zipper foot. Attach the right side of the presser foot pin to the holder when sewing the left side of the zipper.

- Attach the left side of the presser foot pin to the presser foot holder when sewing the right side of the zipper.

- Stitching around the zipper.

🚫 Note:

When sewing, be sure that the needle does not touch the zipper, otherwise the needle may bend or break.

- Remove the basting and press.

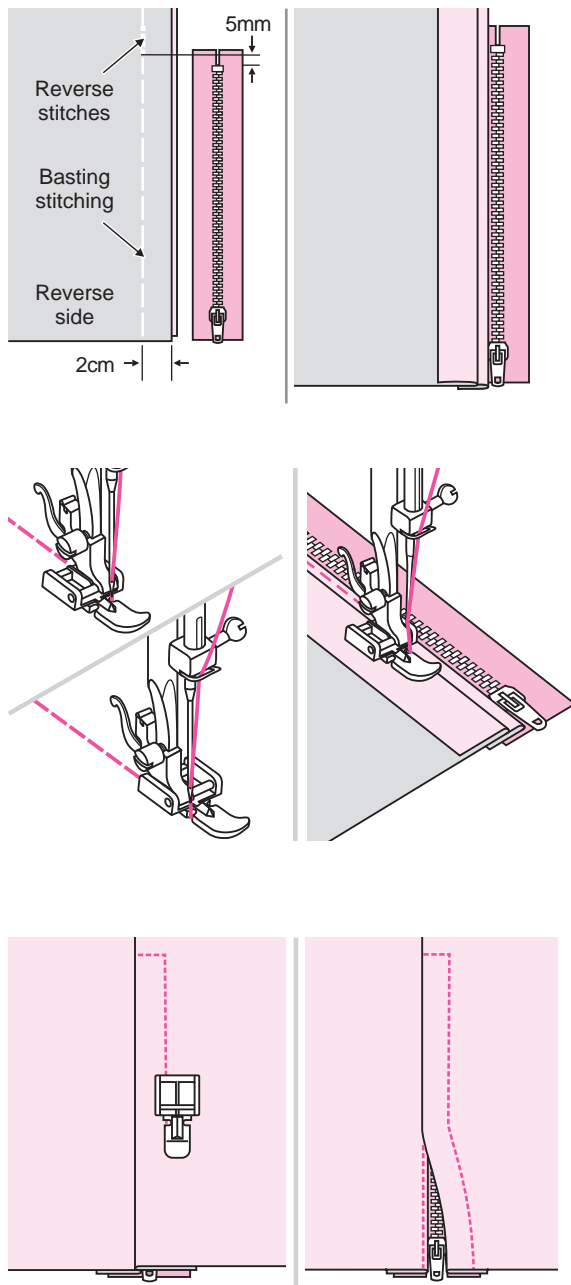

Inserting a side zipper

- Place the right sides of the fabric together. Sew a bottom seam 2cm from the right edge to the zipper bottom stop position. Sew a few stitches in reverse to lock. Increase the stitch length to maximum, set the tension below 2, and baste the remaining length of the fabric.
- Fold back to the left seam allowance. Turn under the right seam allowance to form 3mm (1/8 inch) fold.
- Attach the zipper foot. Attach the right side of the presser foot pin to the holder when sewing the left side of the zipper. Attach the left side of the presser foot pin to the presser foot holder when sewing the right side of the zipper.
- Stitch the left side of zipper from bottom to top.
- Turn the fabric right side out, stitch across the lower end and right side of zipper.
- Stop about 5cm (2 inches) from the top of zipper. Remove the basting and open the zipper. Stitch the remainder of the seam.

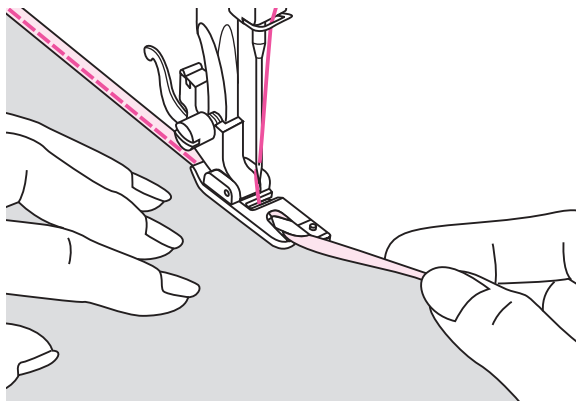
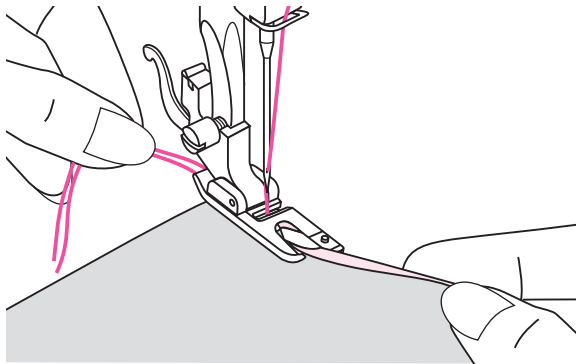
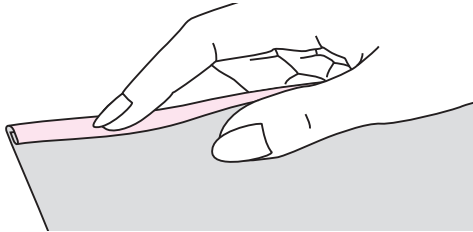

Narrow hemming

The rolled hemming foot is used to stitch the narrow rolled hems usually found on shirt tails, table linens and along the edge of frills.

* The rolled hemming foot accessory is optional. It is not included with this machine.

Fold edge of fabric over about 3mm (1/8 inch), then fold it over again 3mm (1/8 inch) for about 5cm (2 inches) along the edge of the fabric.

Insert the needle into the fold by rotating the handwheel toward you, and lower the presser foot. Sew several stitches and raise the presser foot.

Insert the fabric fold into the spiral opening of rolled hemming foot. Move fabric back and forth until the fold forms a scroll shape.

Lower the presser foot and start sewing slowly guiding the raw edge of the fabric in front of the rolled hemming foot evenly into the scroll of the foot.

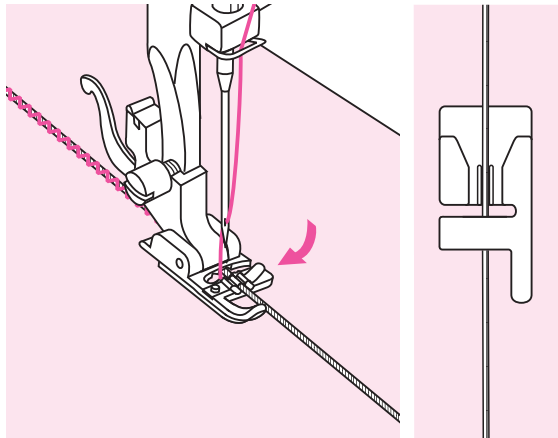
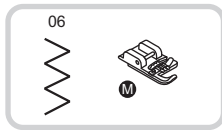

Cording

Used for embellishing 1 to 3 cords or decorative threads.

Sew over one strand of cording to create a pretty swirled design on a jacket or vest or sew over three strands of cording for border trims. Pearl cotton, knitting yarn, embroidery floss, lace thread, fine wool or lily yarn can be used for cording.

* The Cording foot accessory is optional. It is not included with this machine.

Single cording

Mark the design on the fabric.

Insert the cord in the center groove of the cording foot from the right side opening.

Place the cord under the grooves of the cording foot and pull the cord about 5cm (2 inches) behind the foot.

The grooves under the foot will hold the length of the cord in place while the stitches are being formed over the cord.

Select the stitch and adjust the stitch width so that the stitches are just covering the cord.

Lower the foot and sew slowly, guiding the cord over the design.

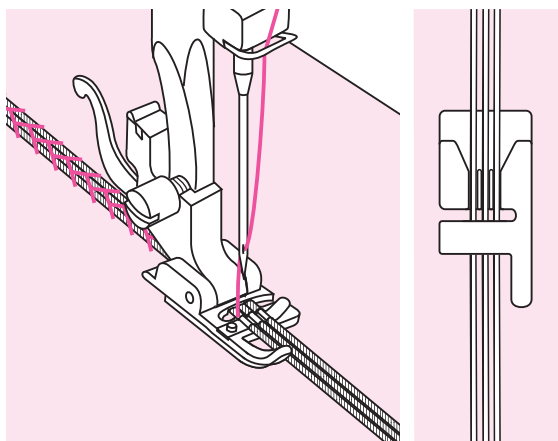
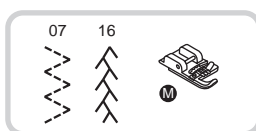

Triple cording

Mark the design on the fabric.

Insert three cords into the grooves of the foot from the right side opening.

Place the cord under the grooves of the cording foot and pull the cord about 5cm (2 inches) behind the foot.

The grooves under the foot will hold the length of the cord in place while the stitches are being formed over the cord.

Select the stitch and adjust the stitch width so that the stitches are just covering the cord.

Lower the foot and sew slowly, guiding the cord over the design.

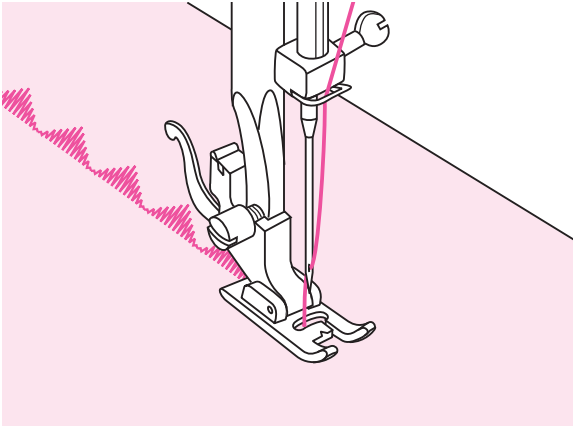

Satin stitch sewing

Use the decorative stitch foot for satin stitching and sewing decorative stitches. This foot has a full indentation on the underside to allow easy sewing over the thickness of the stitches formed by closely spaced zigzag stitches, and even feeding of the fabric.

To tailor the satin or decorative stitch pattern, you may adjust the length and width of the pattern by pressing the stitch length and width adjustment buttons. Experiment with fabric scraps until you get the desired length and width.

Note:

When sewing very thin fabrics, it is suggested that you use interfacing on the backside of the fabric.

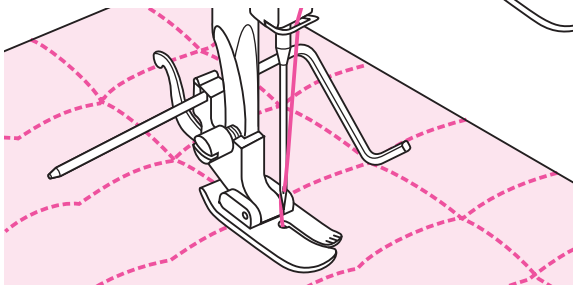
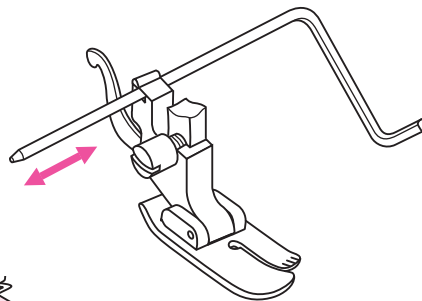
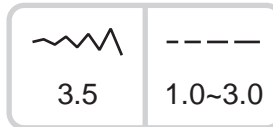
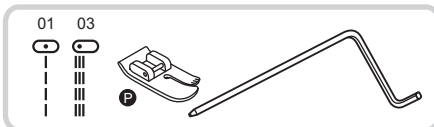

Quilting

Sandwiching batting between the top and bottom layers of fabric is called "Quilting". The top layer is usually formed by multiple geometrically shaped pieces of materials joined together.

* The Straight stitch foot accessory is optional. It is not included with this machine.

Insert the quilt guide in the presser foot holder as illustrated and set the space as you desire.

Sew the first row and move over the fabric to sew successive rows with the guide riding along the previous row of stitching.

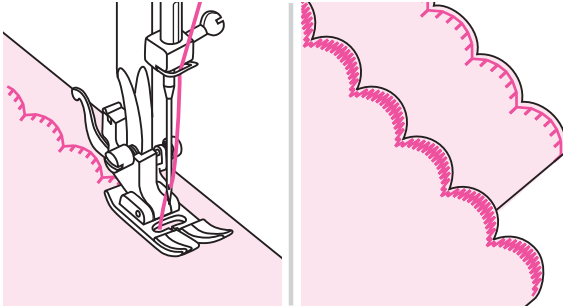
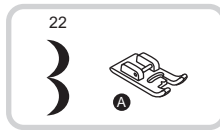
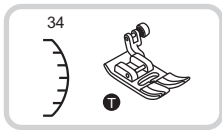

Scalloping

The wave-shaped repeating pattern that looks like shells is called "scalloping". It is used on the collars of blouses and to decorate the edges of projects.

Stitch along the edge of the fabric, making sure not to sew directly on the edge of the fabric.

* For better results, apply spray starch onto the fabric and press with a hot iron before it is sewn.

Trim along the stitches.

* Be careful not to cut the stitches.

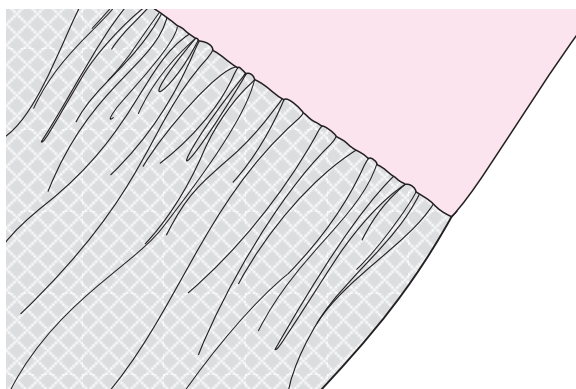
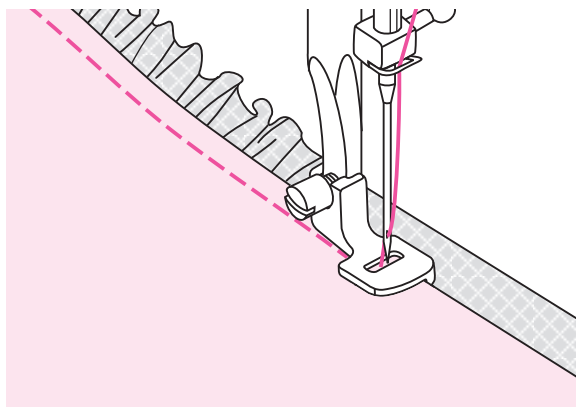
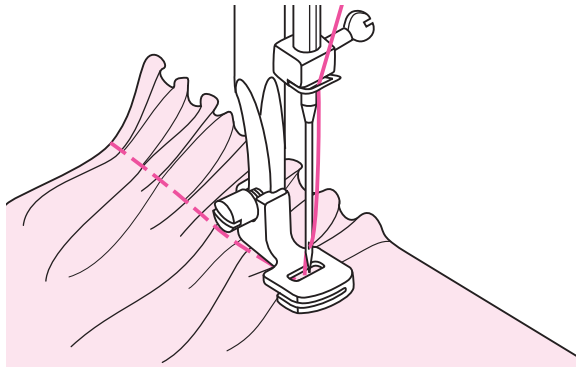

Gathering

The Gathering Foot is used for gathering fabrics. Ideal for clothing as well as home decor, works best on thin to medium weight fabrics.

* The Gathering foot accessory is optional. It is not included with this machine.

Gathered fabric

Remove the presser foot holder and attach the gathering foot, lowering the tension setting to below 2.

Place fabric to be gathered under presser foot to the right of the presser foot.

Sew a row of stitching, keeping the raw edge of fabric aligned with the right edge of foot.

Suitable for light to medium weight fabrics. If your fabric is light, such as batiste or lace, you will have more gathers.

To gather and attach gathered fabric in one step

Look closely at the gathering foot to see a slot on the bottom.

When using the slot, you can gather the bottom layer of the fabric while attaching it to a flat top layer, such as the waistband on a dress bodice.

- Remove the presser foot holder and attach gathering foot.
- Place the fabric to be gathered with right side up under the foot.
- Place top layer of the fabric right side down in the slot.
- Guide the two layers as illustrated.

Note:

- When testing machine for adjustments to achieve desired fullness, work with 10" increments of the fabric, trims or elastic. This makes it easier to determine the adjustments and how much change is needed for your project. Always test on your project fabric and on the same grainline as will be used in your finished project.
- slow to medium speed for better fabric control.

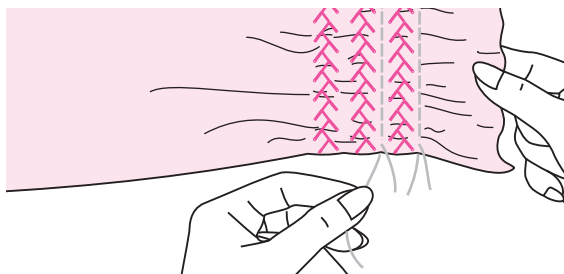
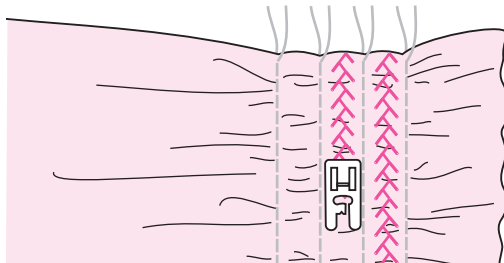
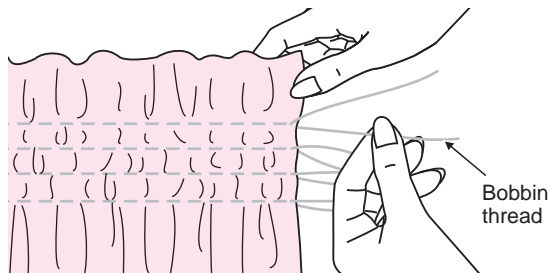
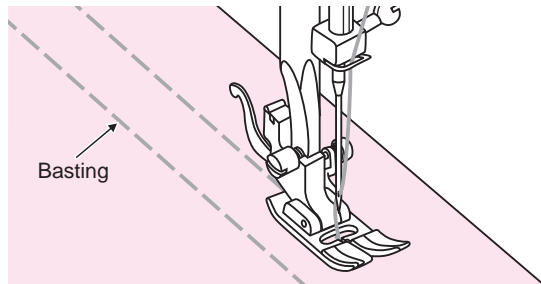

Smocking

The decorative stitch created by stitching or embroidering over gathers is called "smocking".

It is used to decorate the front of blouses or cuffs. The smocking stitch adds texture and elasticity to fabric.

Use the standard presser foot to sew basting lines 1cm (3/8 inch) apart, across the area to be smocked.

Knot the threads along one edge.

Pull the bobbin threads and distribute the gathers evenly. Secure the threads at the other end.

Reduce the tension, if necessary and sew decorative pattern stitches between the straight seams.

Pull out the basting.

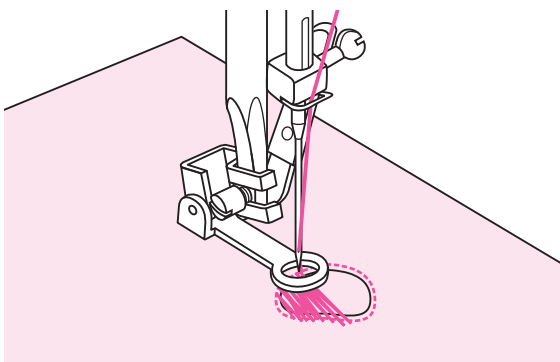
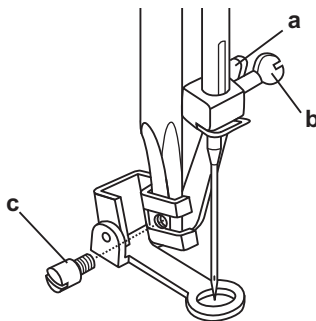
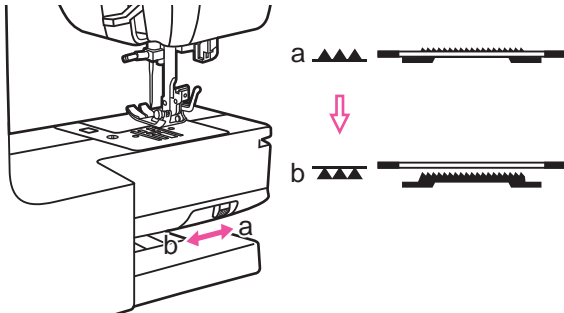
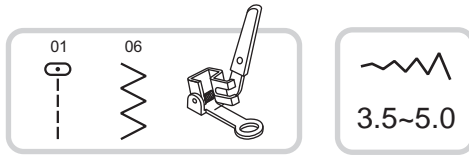

Free motion darning, embroidery and monogramming

* The Quilt foot accessory is optional. It is not included with this machine.

Move the drop feed control to "▲▲▲" to lower the feed dogs.

Remove the presser foot holder, and attach the quilt foot to the presser foot holder bar.

The lever (a) should be behind the needle clamp screw (b). Press the darning foot on firmly from behind with your index finger and tighten the screw (c).

Darning

First sew around the edges of the hole (to secure the threads). Working from left to right, sew over the hole in a constant and continuous movement.

Turn the work by 1/4 and sew over the first stitching moving the work slower over the hole to separate the threads and not form big gaps between the threads.

➡ Note:

Free motion darning is accomplished without the sewing machine internal feed system. Movement of the fabric is controlled by the operator. It is necessary to coordinate sewing speed and movement of fabric.

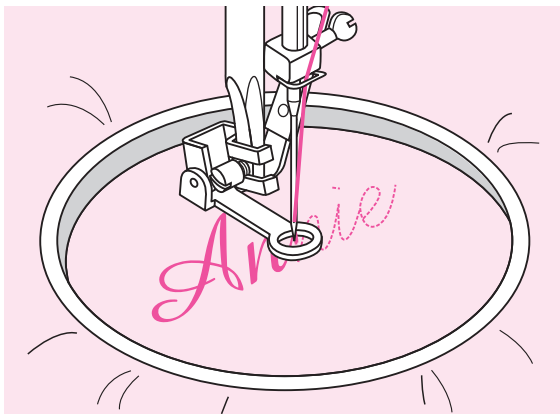
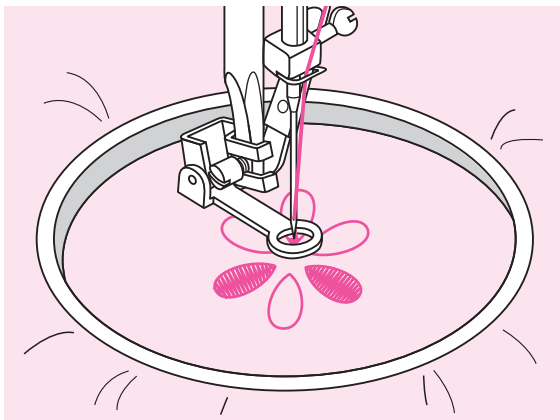
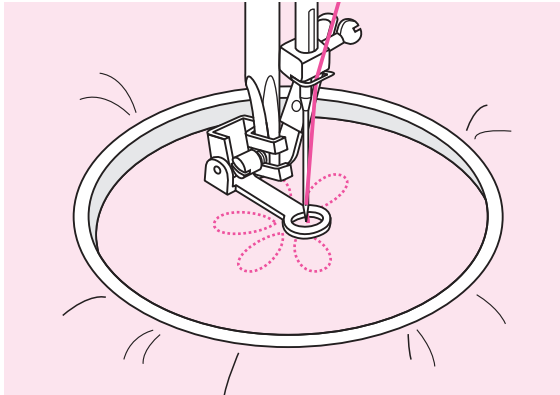

Embroidery

Select zigzag stitch pattern and adjust the stitch width as desired.

Stitch along the outline of the design by moving the embroidery hoop. Make sure to maintain a constant speed.

Fill in the design working from the outline towards the inside. Keep the stitches close together.

You will get longer stitches by moving the hoop faster and shorter stitches by moving the hoop more slowly.

Secure with a reinforcement stitches at the end by press Auto-lock button.

Monogramming

Select the zigzag stitch pattern and adjust the stitch width as desired. Sew at a constant speed, moving the hoop slowly along the lettering. When the letter is finished. Secure with a reinforcement stitches at the end by press Auto-lock button.

* Embroider hoop is not included with the machine.

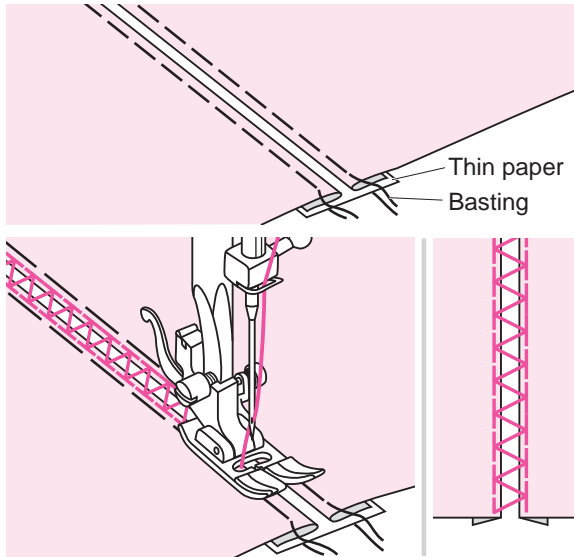
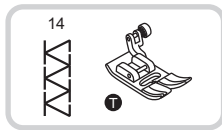

Fagoting

Stitching across an open seam is called "fagoting". It is used on blouses and children's clothing. This stitch is more decorative when thicker thread is used.

- Separate the folded edges of the fabric pieces with a gap of 4mm (1/8 inch) and baste them onto a piece of thin paper or water-soluble stabilizer sheet.
- Align the center of the presser foot with the center of the two pieces of fabric and begin sewing.
- After sewing, remove the paper.

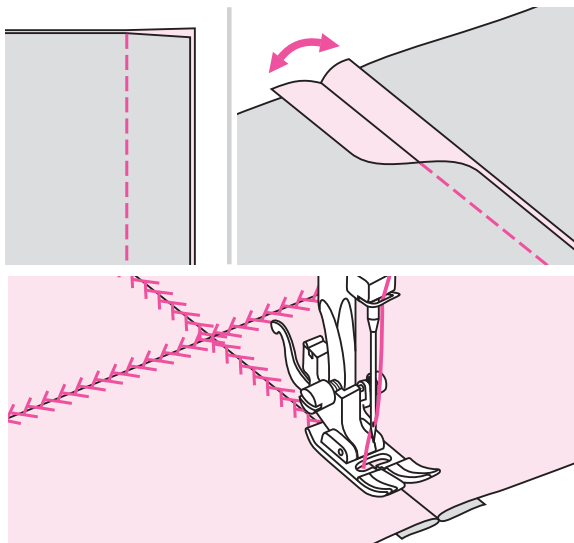
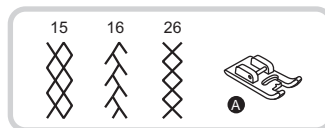
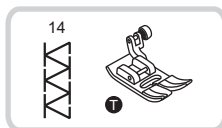

Patchworkstich

- Place the two pieces of fabric with the right side together and sew with the straight stitch.
- Open the seam allowances and presses it flat.
- Place the center of the presser foot on the seam line of the joined pieces of fabric and sew over the seam.

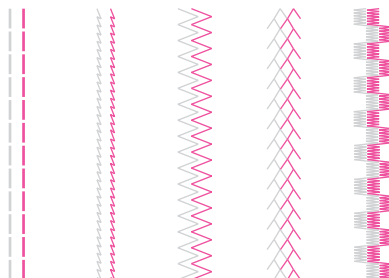
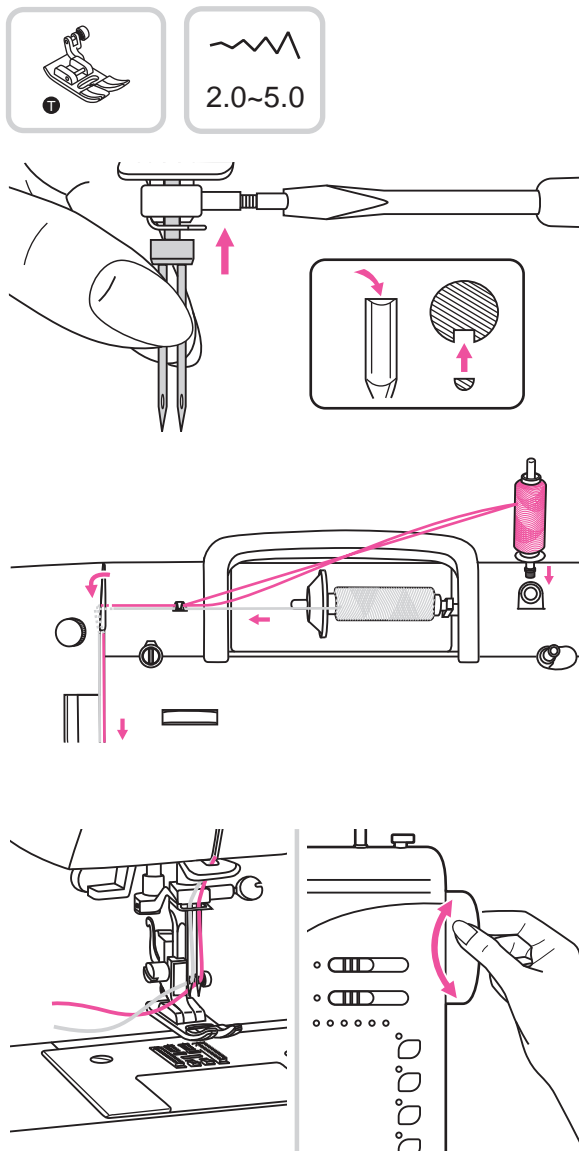

Twin needle

* The twin needle is optional. It is not included with the accessories.

Insert the twin needle.

⚠ Attention:

When using twin needles, use the standard presser foot (T) regardless of what kind of sewing will be carried out.

Use only twin needle assemblies with max. 2mm needle distance.

Follow the instructions for single-needle threading using the horizontal spool pin. Thread through the left needle.

Set the auxiliary spool pin (included with the accessories) into the hole on the top of the machine. Thread through remaining points, making certain to omit the thread guide above the needle and pass thread through the right needle.

Thread each needle separately.

➡ Note:

Make sure that the two threads used to thread the twin needle are of the same weight. You can use one or two colors.

Before sewing adjust the stitch width. Turn the handwheel to check the needle clearance, so that needle does not hit the needle plate.

When sewing with twin needle, always proceed slowly, and make sure to maintain a low speed to insure quality stitching.

Select a stitch pattern and start to sewing.

Except the Patterns 17-20, the other patterns can be used.

➡ Note:

When sewing with twin needle, always proceed slowly, and make sure to maintain a low speed to insure quality stitching.

Walking foot

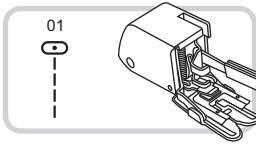

* The walking foot accessory is optional. It is not included with this machine.

Always try to sew first without the walking foot accessory which should be used only when necessary. It is easier to guide the fabric and you have a better view of the seam when using the standard, regular foot on your machine.

Your sewing machine offers excellent stitch quality on a wide range of fabrics from delicate chiffons to multiple layers of denim.

The Walking Foot accessory equalizes the feeding of the upper and lower layers of fabric and improves the matching of plaids, stripes and patterns. It also helps to prevent uneven feeding of very difficult fabrics. The Walking Foot accessory equalizes the feeding of the upper and lower layers of fabric and improves the matching of plaids, stripes and patterns. It also helps to prevent uneven feeding of very difficult fabrics.

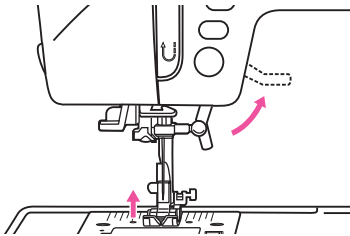

Lift the presser foot lifter to raise the presser foot bar.

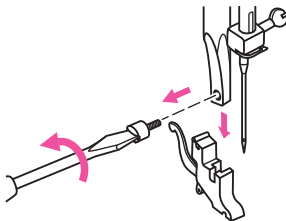

Remove the presser foot holder by unscrewing (counterclockwise) the presser bar attaching screw.

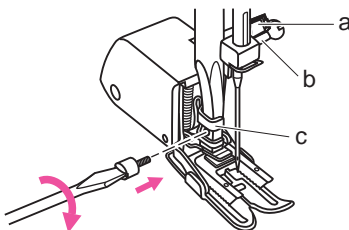

Attach the Walking Foot to the machine as follows:

- The arm (a) should fit into above the needle screw and clamp (b).
- Slide the plastic attaching head (c) from your left to right so that it is fitted into the presser foot bar.
- Lower the presser foot bar.
- Replace and tighten (clockwise) the presser bar attaching screw.
- Make sure both the needle screw and the presser bar attaching screw are tightly secured.

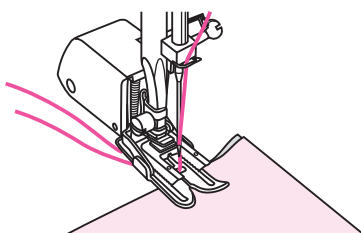

Draw the bobbin thread up and place both the bobbin thread and the needle thread behind the walking foot attachment.

Warning functions

Warning beeping sound

- When operating correctly
: 1 beep
- When operating incorrectly
: 3-short beeps
- When the sewing machine is
in trouble and can't sew
: 3-short beeps

It means that the thread is twisted or jammed and the hand wheel axle can't move.

Please look through the "Trouble shooting guide" on page 69/ 70 to find the solution.

After the problem has been solved, the machine will continue to sew.

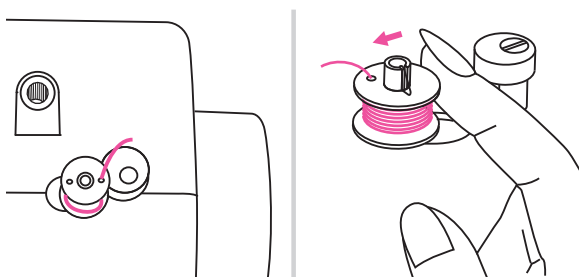

Return bobbin winder spindle to left

If you press any button on the machine when the bobbin is full or the bobbin winder spindle is in the right position, then the machine will beep 3 times as a warning.

Return the bobbin winder spindle to the left position.

Note:

If the problem is still not solved, please contact your local dealer.

Attention:

During the sewing, if the thread get jammed inside the hook stopping the needle from moving and you continue pressing the foot control, the security switch will stop the machine completely. In order to restart the sewing machine, you will have to turn the on/off switch to the OFF position and then ON again.

Maintenance

Attention:

Disconnect the power cord from the wall socket before cleaning the screen and sewing machine surface, otherwise injury or electrical shock may result.

Cleaning the sewing machine surface

If the surface of the sewing machine is dirty, lightly soak a cloth in mild detergent, squeeze it out firmly and then wipe the surface. After cleaning it once in this way, wipe the surface again with a dry cloth.

Attention:

This machine is equipped with a 100mW LED lamp. If lamp replacement is needed, please contact nearest authorized retailer.



Cleaning the hook

If lint and bits of thread accumulate in the hook, this will interfere with the smooth operation of the machine. Check regularly and clean the stitching mechanism when necessary.

Attention:

Disconnect the machine from the wall outlet before carrying out any maintenance.

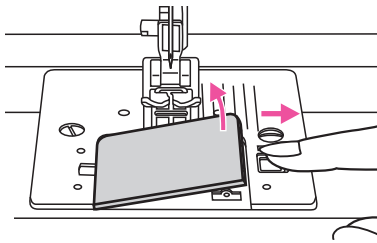

Remove the needle plate cover and bobbin.

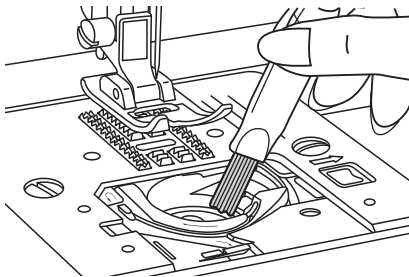

Clean the bobbin holder with a brush.

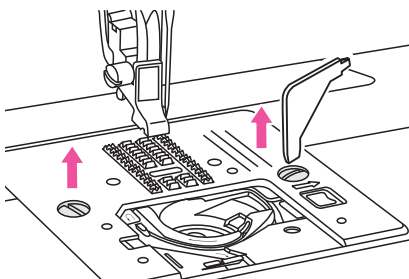

Remove the needle, presser foot and presser foot holder.

Remove the screw holding the needle plate and remove the needle plate.

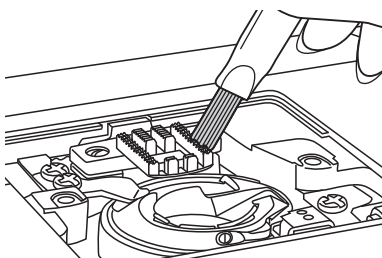

Clean the feed dog and bobbin case with a brush.

Also clean them, using a soft, dry cloth.

Trouble shooting guide

Before calling for service, check the following items. If the problem still persists, contact the place of purchase or your nearest authorized dealer.

Problem	Cause	Correction	Reference
Upper thread breaks	1. The machine is not threaded correctly.	1. Rethread the machine.	16
	2. The thread tension is too tight.	2. Reduce the thread tension (lower number).	29
	3. The thread is too thick for the needle.	3. Select a larger needle.	23
	4. The needle is not inserted correctly.	4. Remove and reinsert the needle (flat side towards the back).	20
	5. The thread is wound around the spool holder pin.	5. Remove the reel and wind thread onto reel.	16
	6. The needle is damaged.	6. Replace the needle.	20
Lower thread breaks	1. The bobbin case is not inserted correctly.	1. Remove and reinsert the bobbin case and pull on the thread. The thread should pull easily.	15
	2. The bobbin case is threaded wrong.	2. Check both bobbin and bobbin case.	15
	3. The lower thread tension is too tight	3. Loosen lower thread tension as described.	-
Skipped stitches	1. The needle is not inserted correctly.	1. Remove and reinsert needle (flat side towards the back).	20
	2. The needle is damaged.	2. Insert a new needle.	20
	3. The wrong size needle has been used.	3. Choose a needle to suit the thread.	23
	4. The foot is not attached correctly.	4. Check and attach correctly.	21
	5. The machine is not threaded correctly.	5. Rethread the machine.	16
Needle breaks	1. The needle is damaged.	1. Insert a new needle.	20
	2. The needle is not correctly inserted.	2. Insert the needle correctly (flat side towards the back).	20
	3. Wrong needle size for the fabric.	3. Choose a needle to suit the thread and fabric.	23
	4. The wrong foot is attached.	4. Select the correct foot.	28
	5. The needle clamp screw is loose.	5. Use the screwdriver to firmly tighten the screw.	23
	6. The presser foot that is used is not appropriate for the type of stitch that you wish to sew.	6. Attach the presser foot that is appropriate for the type of stitch that you wish to sew.	28
	7. The upper thread tension is too tight.	7. Loosen the upper thread tension.	29
Loose stitches	1. The machine is not correctly threaded.	1. Check the threading.	16
	2. The bobbin case is not correctly threaded.	2. Thread the bobbin case as illustrated.	15
	3. Needle/ fabric/ thread combination is wrong.	3. The needle size must suit the fabric and thread.	23
	4. Thread tension is wrong.	4. Correct the thread tension.	29
Seam gather or pucker	1. The needle is too thick for the fabric.	1. Select a finer needle.	23
	2. The stitch length is adjusted wrong.	2. Readjust the stitch length.	26
	3. The thread tension is too tight.	3. Loosen the thread tension.	29

Problem	Cause	Correction	Reference
Seam puckering	1. The needle thread tension is too tight.	1. Loosen the thread tension.	29
	2. The needle thread is not threaded	2. Rethread the machine.	16
	3. The needle is too heavy for the fabric being sewn.	3. Choose a needle to suit the thread and fabric.	23
	4. The stitch length is too long for the fabric.	4. Make stitch dense.	26
	5. If you are sewing thin fabric.	5. Sew with stabiliser material under the fabric.	-
Patterns are distorted	1. The correct presser foot is not used.	1. Select the correct foot.	28
	2. The needle thread tension is too tight.	2. Loosen the thread tension .	29
The machine jams	1. Thread is caught in the hook.	Remove the upper thread and bobbin case, turn the handwheel backwards and forwards by hand and remove the thread remnants.	58
	2. The feed dogs are packed with lint.		
The machine is noisy	1. Fluff or oil have collected on the hook or needle bar.	1. Clean the hook and feed dog as described.	58
	2. The needle is damaged.	2. Replace the needle.	20
	3. Slight humming sound coming from internal motor.	3. Normal.	-
	4. Thread is caught in the hook.	Remove the upper thread and bobbin case, turn the handwheel backwards and forwards by hand and remove the thread remnants.	58
	5. The feed dogs are packed with lint.		
Uneven stitches, uneven feed	1. Poor quality thread.	1. Select a better quality thread.	23
	2. The bobbin case is threaded wrong.	2. Remove the bobbin case, the thread and reinsert correctly.	15
	3. Fabric has been pulled.	3. Do not pull on the fabric while sewing, let it be taken up by the machine.	-
The sewing machine doesn't operate	1. The machine is not turned on.	1. Turn on the machine.	13
	2. The machine is not plugged in.	2. Connect the power line plug to the electric outlet.	22
	3. The presser foot lifter is raised.	3. Lower the presser foot lifter.	13
	4. The bobbin winder spindle is in the right position.	4. Return the bobbin winder spindle to the left position.	14

JUKI®

JUKI CORPORATION

2-11-1, Tsurumaki,
Tama-shi, Tokyo 206-8551, JAPAN

PHONE : (81)42-357-2341

FAX : (81)42-357-2379

Copyright © 2015 JUKI CORPORATION.
All rights reserved throughout the world.
Reservados todos los derechos en todo el mundo.
Tous les droits sont réservés à travers le monde.
Tutti i diritti riservati in ogni paese del mondo.

